

THE ELBAS PROJECT – ELECTRIC VEHICLE FIRES AT SEA: NEW TECHNOLOGIES AND METHODS FOR SUPPRESSION, CONTAINMENT, AND EXTINGUISHING OF BATTERY CAR FIRES ONBOARD SHIPS

DEN DANSKE
MARITIME FOND



The Danish Maritime Fund –
Project number 2021-039

Executive Summary

The DBI ELBAS project (Electric Vehicle Fires at Sea: New Technologies and Methods for Suppression, Containment, and Extinguishing of Battery Car Fires Onboard Ships) aimed to develop performance based holistic fire safety strategies for electric cars fires when transported onboard ferries, as electrical vehicles (EV)s form an increasing part of the Danish car fleet.

Fires in EV's traction batteries may not be able to be extinguished or suppressed using standard firefighting techniques alone, and they often require vast amounts of water to extinguish compared to gasoline or diesel engine fires in traditional internal combustion engine (ICE) vehicles. Furthermore, there is a risk of batteries reigniting up to 24-hours or more, after extinguishing, and the toxic smoke and soot produced from such a fire present a danger to the health of both people and the environment. These factors become compounded risks and hazards during maritime travel, where space is often confined, and available firefighting equipment and resources are limited.

The ELBAS project has addressed many of these challenges, examining current practices of tackling battery fires on board ships and developed effective methods and proposes solutions. The solutions identified through the ELBAS project are implementable and affordable in the short-term.

Various fire detection and extinguishing technologies were identified and tested during the ELBAS project in a live fire setup, resembling a ferry vehicle deck, and fire simulations performed using CFD modeling of actual vehicle decks on the ferries. These technologies included several portable mist curtain and undercarriage cooling devices, a couple of battery penetration extinguishing systems, a large thermal fire blanket, a fixed water mist sprinkler system, gas detection, as well as combined firefighting methods. The CFD simulations were able to show that active use of ventilation could be included as part of a fire management strategy under certain fire conditions.

The ELBAS project's results have demonstrated how fire simulation can give insights into how fire and smoke can spread within a vehicle deck, and how current and new firefighting methods including detection and suppression systems perform, given different simulated scenarios of an EV fire.

Furthermore, the ELBAS project has increased awareness of the complexity of EV battery fires and the need for both short- and long-term solutions addressing fire safety issues, which may slow or hinder the fulfilment of the Danish government's green transition goals and the policy goals in the Nordic countries.

Through broad involvement of partners, the ELBAS project has focused on anchoring results and making them immediately applicable in the maritime sector, which has facilitated safer travel in EVs across Denmark and throughout Europe, while reducing risk for potential fatalities and significant damage to property.

The following conclusions regarding EV Fires can be drawn based on analysis of all data from the respective tests used for validation of the CFD simulations, developed to simulate fire spread on board.

Extra attention should be paid to training of crew on ships carrying electric and other modern vehicles, through performing realistic drills involving vehicle deck fires, and including the appropriate protection and correct disrobing procedures post fire, to avoid harmful contamination from chemical exposure.

For portable firefighting tools to have any effect with the fire, their operation must be included when developing vehicle stowage procedures for loading the vessel.

All the fires in the ELBAS tests could be extinguished safely, so with the right firefighting technologies on board, the right training of the crew and a well-coordinated cooperation with the emergency services on land, EVs should not pose an increased safety problem in ferry traffic. The positive message is that fires in EVs on board ferries are manageable and are not something we should necessarily fear more than any other type of fire.

Finally, the ELBAS project provides a foundation for stakeholders in the maritime industry in Denmark and Danish companies manufacturing detection and suppression technologies, to continue to be at the forefront of the development of EV fire safety at sea. Given the many companies across the Blue Denmark who have important roles to play in the battery safety value chain, DBI believe there exists a great potential here in Denmark, to impact and improve EV fire safety and the ships which carry them in operation all around the world.

In relation to these lines for future work, DBI intends to pursue possibilities for follow-up projects. To this end, we would like to extend an invitation to all interested stakeholders to contact us for discussion of mutual interests, conflicting impressions, and potential collaboration so that solutions can continuously be developed.

In conclusion, the issue of EV fire safety onboard ships should not be a barrier to meeting the increasing market demand and support the green transition. The overall conclusion of the ELBAS project is that EV fires on ferries are not to be feared more than any other fire at sea. They can typically be dealt with using the correct technology, education, and training of shipboard personnel, as well as with coordinated cooperation between the ship and with emergency services on land.

The near term practical and concrete solutions identified through the ELBAS project can be implemented immediately and will improve safety of transporting EVs by ship. The ELBAS project provides new knowledge on firefighting equipment and fire strategies which can efficiently contain an EV fire quickly and effectively onboard a ferry vehicle deck.

DBI sees the ELBAS project as just the beginning, and that ELBAS confirms the need for further research into these important fire safety topics.

Terminology and Abbreviations

Electric vehicle (EV) – is a vehicle that has a larger traction battery pack and uses an electric engine for propulsion.

Internal combustion engine vehicle (ICEV) – is a vehicle that uses internal combustion engine for propulsion.

Thermal Runaway (TR) – occurs when one cell or area within the cell of a lithium-ion battery (LIB) achieves elevated temperatures due to thermal failure, mechanical failure, internal/external short circuiting, or other electrochemical abuse, and the battery pack enters a cascade-like process, causing the cell experiencing TR to propagate to neighbouring cells. TR can result in fire, arc flashing, off gassing, and sometimes explosions.

National Fire Protection Association (NFPA) – an international non-profit organization devoted to eliminating death, injury, property and economic loss due to fire, electrical and related hazards.

Closed-circuit television (CCTV) – is a use of video cameras to transmit a signal to a specific place, on a limited set of monitors.

Design fire – An engineering description of the development and spread of fire for a specific fire scenario. Design fire curves are usually described in terms of Heat Release Rate (HRR) versus time.

Fire Dynamics Simulator (FDS) – A computer software using computational fluid dynamics computational fluid dynamics (CFD) principles for solving smoke and fire spread related problems.

Heat release rate (HRR) – Rate at which the energy (heat) is released over time. HRR is measured in kW.

Available safe egress time (ASET) – is a time interval between the ignition of the fire and onset of any condition that may be dangerous for safety of people, i.e. heat flux, pressure, temperatures, height of the smoke layer etc.

State of charge (SOC) – state of charge of an electric battery relative capacity.

Lower flammability limit (LFL) – is the lower end of the concentration range over which a flammable mixture of gas or vapour in air can be ignited at a given temperature and pressure.

Authors

Alexander B. Kleiman – Project Manager
Nicklas S. Koch
Konrad Wilkens Flecknoe-Brown
Elena Funk
Thushadh Wijesekere
Bjarne Paulsen Husted
Blanca Andres Valiente
Sean Meehan
Carsten Møller

Special thanks to

DFDS - Sif Lundsvig, Lena Brandt
MOLSLINJEN - Thomas Bisgaard Jensen
SCANDLINES – Rasmus Nielsen
Stena Teknik - Martin Carlsson
RESC - René Kofod
The Equipment and Technology Providers
The Danish Maritime Authority
The Danish Emergency Management Agency

Carsten Damgaard - DBI
Thomas Hulin - DBI
The Danish Maritime Fund

Client: Danish Maritime Fund – 2021-039
DBI Project number: SIXFU21008

Table of Contents

Executive Summary	ii
Terminology and Abbreviations	iv
0 ELBAS – WP0: Introduction and Background	0-1
0.1 The ELBAS Project.....	0-2
0.1.1 Project Stakeholders.....	0-2
0.2 Introduction and Background.....	0-2
0.3 The Challenge	0-3
0.4 The Lithium-ion Battery Inside of an Electric Car	0-3
0.5 Fire Safety at Sea	0-4
0.6 Project Goals and Objectives.....	0-5
0.7 Project Description	0-5
0.7.1 How Should Fires in Electric Vehicles be Handled?.....	0-5
0.7.2 Other Hazards to be Aware of in Electric Vehicle Fires	0-6
0.7.3 General Principles of the ship’s Fire Main System	0-6
0.7.4 Fixed Fire Extinguishing Systems	0-6
0.7.5 Extinguishing Water may be Poisonous	0-6
0.7.6 Toxic Soot	0-7
0.8 The Ships.....	0-7
0.8.1 PEARL SEAWAYS: Overnight cruise-ferry.....	0-8
0.8.2 EXPRESS 4: High-Speed Ferry	0-8
0.8.3 COPENHAGEN: Ro-Pax Day Ferry	0-8
0.9 Challenges of Shipboard EV fires	0-9
0.10 Research into EV Files.....	0-9
0.10.1 Project Work Packages	0-10
0.11 Project Results	0-10
1 ELBAS – WP1: Human Factors	1-1
1.1 Introduction.....	1-2
1.2 Methodology	1-2
1.2.1 Literature Review	1-2
1.3 The Ships.....	1-2
1.3.1 PEARL SEAWAYS: Overnight Cruise-ferry	1-2
1.3.2 EXPRESS 4: High Speed Ferry.....	1-3

- 1.3.3 COPENHAGEN: Ro-Pax Day Ferry 1-3
- 1.4 Qualitative Interviews 1-3
 - 1.4.1 General Attitude Towards Fire Safety 1-4
 - 1.4.2 The Bridge 1-4
 - 1.4.3 The Vehicle Deck 1-4
 - 1.4.4 Fire Watch 1-5
 - 1.4.5 The Catering and Hotel personnel 1-5
- 1.5 Procedures when a Fire Occurs 1-5
 - 1.5.1 Verifying the Fire 1-5
 - 1.5.2 Ventilation 1-6
 - 1.5.3 Fighting the Fire 1-6
 - 1.5.4 Passengers 1-7
 - 1.5.5 Evacuating the Ship 1-7
- 1.6 Authorities 1-7
 - 1.6.1 Land-based Firefighters 1-7
 - 1.6.2 Understanding Risks related to Li-Ion batteries 1-8
 - 1.6.3 Understanding risk in Relation to Smoke Diving on vehicle decks 1-8
 - 1.6.4 Firefighters – Experience and guidance from land-based emergency services 1-8
 - 1.6.5 Precautions in the Event of a Fire in an Electric Vehicle 1-9
- 1.7 Summary of Insights 1-9
 - 1.7.1 Recommendations for Future Work 1-10
- 2 ELBAS – WP2: Technological Aspects – Fire Scenarios and Technologies 2-1**
 - 2.1 Introduction 2-2
 - 2.1.1 Objective 2-2
 - 2.1.2 Summary 2-2
 - 2.1.3 Introduction 2-3
 - 2.2 Literature Review 2-4
 - 2.2.1 Smoke from EV Fires and Toxicity 2-4
 - 2.2.2 Detection 2-5
 - 2.2.3 Fire Extinguishment Methods 2-8
 - 2.2.4 Recommendations and Conclusion 2-11
 - 2.3 FDS modelling 2-11
 - 2.3.1 Methodology 2-11

2.3.2	Fire Scenarios.....	2-13
2.3.3	Simulation Results	2-16
2.3.4	Recommendations and Conclusions.....	2-18
2.3.5	Modelling and Simulation Approach	2-19
2.4	References	2-19
3	ELBAS – WP3: Live Fire Testing.....	3-1
3.1	Introduction.....	3-2
3.2	Experimental Set-up	3-2
3.2.1	Structure	3-3
3.2.2	Vehicle Arrangement.....	3-3
3.2.3	Measurement Equipment.....	3-5
3.3	Methodology	3-7
3.4	Tested Devices and Technologies.....	3-8
3.4.1	Car Fire Blanket.....	3-9
3.4.2	Extinguishing Lance	3-12
3.4.3	Battery Extinguishing System	3-14
3.4.4	Portable Mist Curtain with Undercarriage Cooling	3-17
3.4.5	Portable Water Mist Curtains.....	3-19
3.4.6	Low-Pressure Water Mist System	3-21
3.5	Additional Findings	3-25
3.5.1	Fire Characteristics	3-25
3.5.2	Gas Measurements and Detection	3-25
3.5.3	Weather Effects	3-26
3.5.4	Structural Response.....	3-26
3.5.5	Use of Sea Water as Extinguishing Medium Sea vs Fresh Water	3-26
3.6	Conclusions.....	3-27
3.7	References	3-28
4	ELBAS – WP4: Fire Drills and Training	4-1
4.1	Introduction.....	4-2
4.2	Onboard Fire Drills & Training	4-2
4.2.1	Fire Drills	4-2
4.2.2	Training Requirements	4-3
4.2.3	Realism of Shipboard Fire Drills.....	4-4

4.3	Realistic Fire Training – Simulated Vehicle Deck with Real Cars	4-5
4.3.1	Realistic Fire-training Set-up of a Vehicle Deck.....	4-5
4.3.2	Simulated Vehicle Deck Set-up.....	4-5
4.3.3	Live Fire Training Course – Modern Vehicle Fires on a Vehicle Deck.....	4-7
4.4	Joint Exercises – Shipboard & Shore Coordinated Response	4-8
4.5	Conclusions and Recommendations.....	4-9
5	ELBAS – WP5: Conclusions and Recommendations.....	5-1
5.1	Conclusions.....	5-2
5.1.1	Results of the Live Fire Tests and Fire Simulations.....	5-2
5.1.2	Active Use of Ventilation as part of a Fire Management Strategy	5-2
5.1.3	Use of Fixed Sprinkler (Drencher or Water Mist) System Provides a Quick Response	5-2
5.1.4	Large Thermal Fire Blanket Over Vehicle	5-3
5.1.5	Battery Extinguishing Systems.....	5-3
5.1.6	Portable Mist Curtain and Undercarriage Cooling	5-3
5.1.7	Combined Firefighting Methods.....	5-4
5.1.8	Specialized Fire Training	5-4
5.1.9	Joint Exercises and Drills with Shipboard and Shore-side Firefighters.....	5-4
5.1.10	Need for a Regularly Updated Fire Risk Assessments	5-4
5.1.11	Crew Size Impacts Available Response.....	5-5
5.2	Recommendations.....	5-5
5.2.1	WP1 Human Factors - Recommendations.....	5-5
5.2.2	WP2 Technological Aspects – Recommendations.....	5-6
5.2.3	WP3: Live Fire Testing - Recommendations	5-7
5.2.4	WP4: Fire Drills and Training - Recommendations.....	5-8
5.3	Misconceptions and Myths	5-8
5.3.1	Risk of Electrocution due to use of Sea Water as Extinguishing Medium.....	5-9
5.3.2	Increased Heat Under an EV.....	5-9
5.3.3	Are EV Fires Manageable?	5-9
5.4	Dissemination Activities	5-9
5.4.1	Table of ELBAS Activities.....	5-9
5.4.2	List of Articles Exposing the ELBAS Project.....	5-10
5.5	Further Research Recommendations	5-11
5.6	Going Forward	5-11

6	ELBAS Appendix - WP2: Technological Aspects - Fire Scenarios and Technologies	6-1
6.1	Limitations and Assumptions	6-2
6.2	Car Categorization	6-3
6.3	Design Fire	6-4
6.4	Critical Ignition Temperature	6-6
6.5	Description of Fire Spread	6-7
6.6	Mesh Sensitivity	6-8
6.6.1	EXPRESS 4	6-8
6.6.2	PEARL SEAWAYS	6-13
6.7	Cold Simulations	6-16
6.7.1	EXPRESS 4	6-16
6.7.2	PEARL SEAWAYS	6-17
6.8	EXPRESS 4 Fire Simulation Details	6-18
6.8.1	Numerical Set-up	6-18
6.8.2	Vehicle Decks (Tier 1 and Tier 2)	6-19
6.8.3	Car Distances and Distribution	6-20
6.8.4	Effect of Location of the Initially Ignited Car	6-22
6.8.5	Effect of the Parking Arrangement	6-24
6.8.6	Effect of Ventilation (Wind/Movement of the Ferry)	6-25
6.8.7	Effects on the Structure	6-27
6.9	PEARL SEAWAYS Fire Simulation Details	6-32
6.9.1	Car’s Placement	6-33
6.9.2	Numerical Set-up	6-33
6.9.3	Simulation Results	6-34
6.9.4	Effects of Smoke Spread	6-35
6.9.5	Effect of Distance Between the Cars	6-37
6.9.6	Fire Spread between the Vehicles	6-38
6.9.7	Effect of HRR	6-39
6.9.8	Effect of Ventilation	6-39
6.9.9	Effect of Sprinklers Modelling	6-40
6.10	References	6-41

0 ELBAS – WPO: Introduction and Background

DEN DANSKE
MARITIME FOND



The Danish Maritime Fund –
Project number 2021-039

0.1 The ELBAS Project

The ELBAS project (Electric Vehicle Fires at Sea: New Technologies and Methods for Suppression, Containment, and Extinguishing of Battery Car Fires Onboard Ships) aims to develop new solutions, training forms and risk assessments that can help improve the fire safety of electric cars on board ferries, as electric cars form an increasing part of the Danish car fleet. The project identified potential solutions and developed mockups for new, near-to-market, effective fire-extinguishing technologies, and firefighting techniques for tackling Electric Vehicle (EV) fires at sea. The conclusions from this project have an emphasis on practical solutions, which are simple, quick, and affordable to implement for Danish ferry and shipping companies.

The ELBAS project ran from October 1st, 2021, until December 31st, 2022. It was made possible thanks to the generous financial support of the Danish Maritime Fund (project number 2021-039.)

0.1.1 Project Stakeholders

This project was completed with the assistance of a wide range of companies focused on the shipping industry. Below is a list of the project stakeholders:

- Project Coordinator: The Danish Institute of Fire and Security Technology (DBI)
- Danish Shipping Companies: DFDS, Scandlines, Molslinjen, and Stena Teknik
- The Danish Maritime Authority (DMA)
- Danish Emergency Services: Danish Emergency Management Agency (Beredskabsstyrelsen) and Danske Beredskaber (in Slagelse municipality)

0.2 Introduction and Background

As an effect from the Danish government's ambitious green transition plan, it is projected that there will be 750,000 electric vehicles (EVs) registered in Denmark by 2030. The increase in EVs on Danish roads is as a major step towards achieving full climate neutrality by 2050. However, while EVs have obvious benefits for decreases in CO₂ emissions from the transportation sector, they present unique and complicated challenges when it comes to fire safety.

After years of having significantly lower sales of EVs compared to Sweden and Norway, Danish sales of EVs are on the rise. In the first half of 2020, EV sales almost doubled from 2019, while sales of internal combustion engine vehicles dropped 31%. Currently, there are approximately 31,900 registered EVs in the Danish car fleet, accounting for 1.2% of personal vehicle transportation.

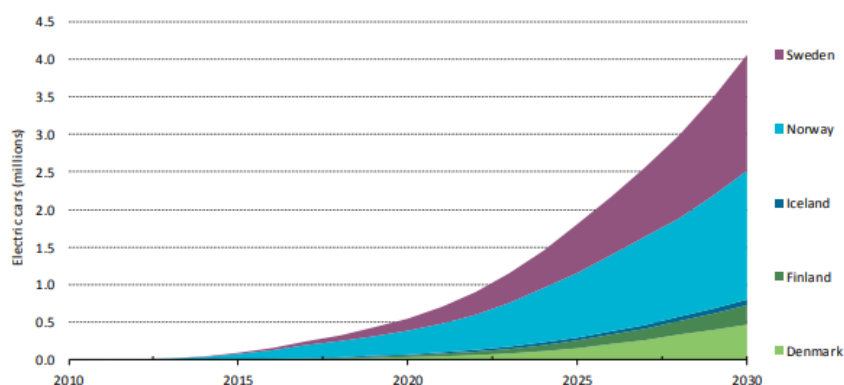

Figure 0.1: Electric vehicle projections in Nordic countries to 2030 [Nordic Energy EV Rapport, 2018]

The policy ambition of Denmark, and the Nordic region overall, to increase the electric car fleet suggests a marked increase in EVs over the coming years. It is projected that 4 million electric cars will be on the road in the region by 2030.

0.3 The Challenge

As more EVs enter the transportation market, issues regarding the containment and extinguishing of battery fires need to be addressed. Battery fires can originate from abuse during regular use, charging treatment, or even thermal abuse exterior to the battery (i.e., a fire originating within the passenger compartment or outside of the vehicle). If the battery is abused to the point of causing an internal short circuit the compromised cell within the battery pack can undergo Thermal Runaway (TR). Sources of abuse range from mechanical abuse (puncture), thermal abuse (overheating), or electrical abuse (under and overcharging) that each can potentially lead to a TR event. Once one cell within the battery pack enters TR a cascade-like process can occur where the cell experiencing TR can propagate to neighboring cells which can result in fire, arc flashing, off gassing, and sometimes explosions.

However, battery fires cannot be extinguished or suppressed using standard fire extinguishers alone and may require vast amounts of water to put out compared to gasoline or diesel engines. Furthermore, there is a risk of batteries reigniting up to 24 hours or more, after extinguishing. Additionally, toxic smoke and soot present a danger to the health of both people and the environment. These factors become compounded risks and hazards during maritime travel, where space is confined, and firefighting equipment and resources are limited.

0.4 The Lithium-ion Battery Inside of an Electric Car

Conventional vehicles often rely on gasoline, diesel, or other fossil fuels for their power source, whereas EVs are powered using a lithium-ion battery (LIB) pack as their powertrain. Firefighting medium and tools have been developed and industry tested when responding to a conventional vehicle fire. Currently, there is not a universal firefighting medium and tools when responding to an EV fire. This skill gap is due to the unique decomposition of LIB packs.

One unique reaction found in the decomposition of LIB cells is the formation of oxygen when the electrodes within the LIB cell decompose. This self-generation of oxygen is one reason that traditional fire extinguishing methods are ineffective against LIB fires. Responding firefighters, not familiar with EV fires, have been humbled by the intensity and tenacity of these fires. The internal chemical reactions within the LIB cells continue to evolve even after all flames emanating from the LIB pack have been extinguished. There have been recorded cases of extinguished EVs reigniting during transport to a secure holding area and even cases of reignition 24 hours after extinguishment. A common practice for shore-side emergency services is to use thermal imaging equipment to monitor hot spots on the failed EV. Since the LIB pack is encased within a protective frame the important aspect of this extended monitoring process is to note any increase in temperature of the neighboring surfaces.

Risk of reignition aside, if a vehicle bursts into flames the priority should be to remove any people inside or around the burning vehicle to safety, prior to fully extinguishing the fire. Extraction tools commonly used by shoreside emergency services, such as hydraulic shears and spreaders, axes, Halligan bar, irons, etc., give professional firefighters the ability to safely extricate trapped passengers. The danger when responding to

an incident involving an EV is that high voltage cables can be routed through the vehicle's frame. Without knowledge of the vehicle's construction, firefighters may expose themselves to electrocution hazards.

With more EVs on the roads and an increasing demand for charging stations, both on land and at sea, there is a need for efficient solutions to management of battery fires. While EV fires at sea are a rare occurrence at present, the likelihood of fire related accidents rises as EVs make up a larger share of vehicles in Denmark. This project aims to address this increased risk and improve safety by identifying practical measures and developing training methods for putting out LIB fires at sea.

Although battery safety has improved greatly and Battery Management Systems (BMS) are now found on most newer vehicles, there are still many older vehicles on the roads. Older vehicles are more likely to be poorly maintained or less compatible with new models of charging docks, increasing the potential of technical issues and risk of fire. Battery damage can be hard for drivers to detect, leading to delayed ignition, and human error using charging docks can lead to accidents. Furthermore, the EV industry lacks common standards for design and safety, such as battery placement, which poses an additional obstacle to fire safety and extinguishing efforts. As EV usage is expected to rise in the coming years, so increases the variety of models potentially having their own and differing BMS. This creates new challenges in establishing efficient standardized safety strategies in case of battery fire, both on land and at sea.

0.5 Fire Safety at Sea

Ferries offer the attractive advantage of transport over long distances, saving EV drivers both km driven and downtime for re-charging breaks during the journey. This introduces the new challenge of allowing passengers to be able to recharge their vehicles while on-board. Some ferry companies have chosen not to offer this option for safety reasons, instead only allowing charging while waiting to board in port. Pressure from the EV consumer and manufacturing markets are great, and it is projected that soon charging onboard for EVs will be common practice.

As charging locations become more commonplace and the range between recharging increases, more and more EVs will be traveling around the country and crossing national borders. The Nordic region has the highest number of EVs per capita in the world, and policy across the Nordic countries favor carbon-reduced transportation, resulting in the number of EVs travelling across Denmark likely to significantly increase soon. These journeys will include travel onboard ferries, which offer the additional benefit of reduced driven kilometers and thus further increasing their range between recharging.

However, with this development comes an increased risk of an EV fire onboard maritime transport, which adds additional demands for shipboard firefighting capabilities, both in terms of training and materials. Since EV fires are already considered complicated on land, the requirements for successful fire containment and extinguishing at sea present the need for reviewing, updating and further developing the current standards and methods.

To support the ongoing development of greener transportation, there is a need for both long and short-term solutions to fire safety concerns, particularly those related to maritime transport of EVs. While firefighting services on land are developing specialized protocols and technology for handling battery fires, these types of fires are still a very rare occurrence and rank much lower than other safety concerns at present. However, the implications of a shipboard battery fire are so great that, when they occur, the crew need to be able to

react quickly and efficiently. This will increasingly be the case, as we move towards 2030 and the Danish government's goal of 750,000 EVs.

As transportation technologies continue to develop, with future EVs presenting a variety of battery types and different modes of charging, fire safety becomes increasingly complex and requires an agile and forward-thinking approach to meet challenges as they arise, as well as short-term solutions to immediately address potential risks.

0.6 Project Goals and Objectives

The overall goal of the ELBAS project is to identify and present new holistic fire strategies, for fighting EV traction battery fires at sea: This to prevent and manage the increasing potential for such fires onboard ferries, as EVs make up a growing segment of the Danish car fleet. The objective is to prevent both the loss of lives and extensive property damage and support the expansion of electric transportation by preparing for fire safety issues. Another goal is to promote Danish influence on future technology for fire safety, and propose efficient solutions, including training, materials, and equipment for managing battery fires at sea.

The activities conducted in the ELBAS project also work to support the Danish government's goal of greatly increasing the number of EVs in Denmark by 2030, as well as the widespread ambition of an increasingly electric car fleet in the Nordic region, in general. The ELBAS project supports several of the UN Global Goals for Sustainable Development. Namely UN SD Goals 7, 9, and 13. Goal 7 is regarding universal access to renewable energy and marked increase in the use of renewable energy. Goal 9 is regarding the development of reliable infrastructure, supporting sustainable industry and investing in innovation and research. Goal 13 is regarding climate measures to restrict the global temperature spike and strengthen resilience and climate adaptations.

The aim of the ELBAS project is to strengthen the position of Danish stakeholders, the Danish maritime industry, and to break down barriers to the green transition in Denmark, while also contributing to the achievement of the UN's global sustainability goals.

0.7 Project Description

The ELBAS project work has been intensive, focusing on delivering immediate, easily implementable, and relatively inexpensive solutions for Danish ferry companies and the crew onboard. While battery fires aboard ships do not happen often, they pose a significant risk to both people and assets and these risks will only increase as EVs and charging stations become more commonplace.

To reduce the risk of future accidents, fire safety measures and specialized equipment must be able to address these risks. To do so, the project proposes methods and equipment working with local emergency services to transfer and further develop existing knowledge of EV-specific firefighting techniques on land to the maritime sector.

0.7.1 How Should Fires in Electric Vehicles be Handled?

Fires involving LIBs have proven to be a challenge. When a lithium battery ignites, it causes an adverse chain reaction that keeps the fire burning. When thermal runaway occurs, the batteries produce oxygen during the decomposition of the LIB cell's electrodes. This reaction creates a fire feedback loop that makes the use of standard dry-powder and CO₂ extinguishers ineffective.

Until now, there are only two options when tackling such fires:

- Simply let the fire burn until the battery runs out of power and the fire will put itself out.
- Douse the fire with thousands of liters of water, which is far more than what it takes to extinguish any fire from a gasoline or diesel engine.

Neither of these options are particularly feasible on board a ship, where vehicle deck space is limited and confined, and extra weight effecting the stability of the vessel is of concern.

0.7.2 Other Hazards to be Aware of in Electric Vehicle Fires

EV fires present additional challenges to emergency response services as although the ensuing fires can be controlled utilizing normal procedures, there is the possibility of the battery itself reigniting after a short period and all the way up to 24+ hours later.

If punctured, breached, or otherwise damaged, heat can build rapidly inside the compromised battery cells and spread to surrounding cells in a cascade-like process called thermal runaway, which can lead to fire, arc flashing, off gassing, and sometimes explosions.

Firefighters typically also lack proper protective equipment to handle or remove the battery's energized lithium-ion cells, as there is no practical way for first responders to drain the potentially massive amount of energy still trapped in an unstable battery. A vehicle's frame could be energized, but firefighters lacked special tools to test for it.

0.7.3 General Principles of the ship's Fire Main System

The fire main is a system consisting of sea inlet(s), suction piping, fire pumps and a distributed piping system supplying fire hydrants, hoses and nozzles located throughout the vessel. Its purpose is to provide a readily available source of water to any point throughout the vessel which can be used to combat a fire and is considered the backbone of the fire-fighting systems onboard a vessel. Through the fire main system, the firefighter is provided with a reliable and versatile system capable of providing a number of different methods with which to engage a fire.

0.7.4 Fixed Fire Extinguishing Systems

Some fixed fire extinguishing systems are not suitable to control the type of fire seen with EVs, where cooling of the battery pack is key to control thermal runaway (TR).

For example, vehicle decks on ships are normally protected by a fixed firefighting drencher or water mist system. Water is supplied by the fire main system. Such systems are designed and dimensioned for extinguishing fires on vehicle decks covering fixed zones and have nozzles located above the vehicles.

0.7.5 Extinguishing Water may be Poisonous

A problem, however, is the extinguishing and cooling water which is produced when fighting such a fire and storing a burnt-out battery in a water basin.

Analyses from a Swiss study on the subject showed that the chemical contamination of the extinguishing water exceeded the acceptable threshold values for industrial wastewater by a factor of 70; the cooling water is even up to 100 times above threshold values. It is important that this highly contaminated water does not

enter a sewage system without proper treatment. While onboard a ship, extinguishing water would either be collected in the bilge system or go directly overboard, in an emergency at sea safety of life and property normally has priority over environmental concerns. Despite this, the potential for contaminated extinguishing water should also be taken into consideration.

0.7.6 Toxic Soot

The soot from an EV fire contains large amounts of cobalt oxide, nickel oxide and manganese oxide. These heavy metals cause severe allergic reactions on unprotected skin. Clean-up after an EV fire is a job for suitably trained personnel donning the appropriate personal protective equipment.

The above factors present an even greater risk when a fire occurs at sea, on board ships where space is confined, and firefighting resources are limited. Danish and international ferry operators are facing these realities today and are interested in having new fires safety challenges with EV fires addressed promptly.

0.8 The Ships

Fire safety on board ships is traditionally covered by IMO regulations¹, Flag state and national requirements, and by classification society rules and notations. For European flagged passenger vessels operating in a domestic trade, are subject to the EU Passenger Ship Directive (2009/45/EC). All three shipping companies and vessels included in the ELBAS project, operate in accordance with all the applicable requirements and current legislation.

To address the issues surrounding EV fire safety onboard ferries, the ELBAS project has investigated three different passenger ship types, which are representative of those in operation by Danish ferry operators.

The three different types of ferries are:

- Overnight Cruise-Ferry – with a totally enclosed vehicle deck, and a retractable car deck
- High-Speed Ferry – two vehicle decks, fully open at stern and opening forward upper car deck
- Ro-Pax Day Ferry – two full height vehicle decks, lower enclosed and upper open at either end

An overnight ferry will typically have hotel style accommodations for passenger and the crew in cabins, and may only have one or two loading and unloading of passengers and on the vehicle deck. While a day ferry typically has many voyages during a day, involving multiple loading and unloading of passengers and on the vehicle deck.

One of each of these ship types, from three different Danish ferry companies was selected. The ships each service different routes of varying distances and vary significantly in age, vessel and crew size, and with three different vehicle deck configurations.

¹ IMO regulations refer to *Ro-ro passenger ship* (which means a passenger ship with ro-ro spaces or special category spaces) and to *High speed passenger craft* (which are passenger ships built subject to the IMO's **HSC Code** - International Code of Safety for High Speed Craft.) For the sake of simplicity, these ship types in the ELBAS project are referred to as Ferries and are further distinguished by the commonly used descriptions of: an Overnight Cruise-Ferry, High-Speed Ferry, and a Ro-Pax Day Ferry. All three ship types have ro-ro cargo spaces, which in the ELBAS project are referred to as *vehicle decks*.

0.8.1 PEARL SEAWAYS: Overnight cruise-ferry

The PEARL SEAWAYS, formerly PEARL OF SCANDINAVIA and originally delivered as ATHENA, is a cruise ferry built in 1989 in Turku, Finland. The ship is Denmark's largest passenger ship with an overnight capacity of 1,832 passengers in 703 cabins. The PEARL SEAWAYS sailed on DFDS's Copenhagen-Oslo route since 2001, and as of June 2020, her route also includes a stop in Frederikshavn. The overnight voyage between takes approximately 19- hrs.

In November 2010, the ship experienced a fire on the vehicle deck, in an EV left charging (unauthorized) onboard². This was the only known EV fire incident to have occurred onboard a Danish ferry, at present time. Following the fire, the ship was refitted and given its current name.

0.8.2 EXPRESS 4: High-Speed Ferry

The EXPRESS 4 is a high-speed catamaran ferry built in 2018 at the Austal shipyard in Australia. EXPRESS 4 sails the route(s) between Aarhus/Ebeltoft and Odden, Denmark and has a capacity for 1006 passengers. The ship operates on shorter crossings (and does not have overnight accommodation for passengers sailing onboard. Instead, passengers spend time in the ship's lounges, where food and a large seating area are available.

The EXPRESS 4 is the fastest vessel of the ones examined in ELBAS, capable of reaching speeds of 40.5 knots (75 km/h), allowing for multiple journeys during a day, involving multiple loading and unloading of passengers and on the vehicle deck. The types of passengers sailing onboard EXPRESS 4 are typically persons who need a quick route to go from Zealand to Jutland without passing over the island of Fyn.

The EXPRESS 4, unlike the other two vessels investigated by this report, is constructed using aluminum, which potentially makes the ship more vulnerable to the effects of a fire. However, EXPRESS 4 is constructed to, and fully meets, all of the statutory fire safety requirements for such vessels.

0.8.3 COPENHAGEN: Ro-Pax Day Ferry

The COPENHAGEN is a Ro-pax day ferry, completed at the Fayard A/S shipyard in Denmark and was delivered to Scandlines in 2016. A Ro-pax day ferry is a Roll-on/roll-off ship designed to carry wheeled cargo, such as cars, motorcycles, and trucks that can drive on and off the ship on their wheels. The ship sails the Gedser-Rostock ferry route between Denmark and Germany together with her sistership, BERLIN and has a capacity for 1,300 passengers.

The COPENHAGEN has two full height vehicle decks, and is similar to both the PEARL SEAWAYS in the layout of the lower vehicle car deck and to the EXPRESS 4, with the COPENHAGEN's partially open upper vehicle deck. As a day ferry, the COPENHAGEN does not provide any overnight accommodations onboard for passengers, but the ship has a selection of restaurants allowing passengers to buy food and relax for their approximately 2-hr journey.

The PEARL SEAWAYS, EXPRESS 4 and COPENHAGEN are subject to regular safety inspections, and all are certified in full compliance with the Danish Flag Sate requirements. Each of three ferries was visited during the ELBAS project, and their crews were interviewed regarding onboard fire safety and the challenges of EV

² Division for Investigation of Maritime Accidents of the Danish Maritime Authority/ Danish Maritime Accident Investigation Board, "PEARL OF SCANDINAVIA Fire," pp. 1–14, November 2010.

fires specifically. In addition, the vehicle decks of these ferries were modeled using computational fluid dynamic tools, to perform fire simulations of various fire scenarios.

0.9 Challenges of Shipboard EV fires

Battery fires are complicated fires to extinguish, even for well trained professional full-time land-based firefighters. So, it is to be expected that they are even more so for seafarers, where fires are a rarity. Some of the potential risks and challenges needing to be addressed are:

- The EV itself (battery has risk of thermal runaway, particularly toxic smoke/soot/extinguishing water, creates its own fire with production of oxygen, not much space available for isolation and firefighting making it difficult to access and extinguish)
- Lack of specialized training for shipboard firefighters.
- Lack of effective fire suppression and extinguishing equipment on board.
- Risk of fire spreading from other burning cars or trucks on board.
- Risk of using incorrect, poor quality, or unauthorized charging cables.
- Saltwater environment.

Shore-side emergency services have developed methods and techniques to tackle fires more effectively in EVs. This experience of handling such complex fires can greatly benefit marine firefighters, so an important component of the ELBAS project is to bring together crew members of shipboard fire teams with their counterparts from shore, and to conduct realistic joint firefighting exercises and training with EV fires. This will promote improved and efficient fire strategies and the sharing of best practices and lessons learned from EV fires.

0.10 Research into EV Fires

The ELBAS project has been focused on identifying practical and concrete solutions, which can be implemented immediately improving the safety of transporting EV by ship. The identified solutions in ELBAS provide knowledge of which firefighting equipment and fire strategies are most efficient to contain EV fires quickly and effectively.

Several large multi-year R&D projects have been underway addressing fire safety of Ferries, such as the EU Horizon Europe Project LASH FIRE and the German national funded project ALBERO, which have work packages investigating many of these issues. While awaiting results and final conclusions from these multi-year projects, it was felt that stopgap measures were needed which can quickly be put into place, in order to keep the passengers, crew and first responders/shipboard firefighters safe, when faced with added risks, dangers, and complexities of shipboard EV fires. It is the goal of ELBAS to provide this.

This project addresses many of these challenges, examining current practices of tackling battery fires on board ships and developing effective methods and propose solutions. The issue of fire safety should not be a barrier to meeting the increasing market demand and support the green transition.

0.10.1 Project Work Packages

WP1: Interview stakeholders on training methods and competencies. Fact finding from and field study at land-based/shore-side emergency services.

WP2: Screen current technologies and methods both for maritime and on-shore use – present hypotheses and design criteria. Mapping existing methods to suppress and extinguish fires in electrical cars.

WP3: Develop experimental test set-up and conduct tests – combining existing solutions, applying technology from other industries, or trying out completely new solutions. Goal: Present a list of potential solutions.

WP4: Evaluate current drills and training methods, perform specialized training, and identify future training needs.

WP5: Final evaluation, conclusions, and recommendations, including dissemination activities (published articles, presentations at seminars, workshops, and conferences.)

0.11 Project Results

The outcome of the ELBAS project is the development of performance based holistic fire safety strategies for EV battery fires on ferries, focusing on delivering solutions for the Danish maritime sector that are implementable and affordable in the short-term. This was realized, in part, through transfer and further development of existing knowledge of EV-specific firefighting on land to the maritime sector through interdisciplinary cooperation, and in part by original research, experimentation, analysis and evaluation leading to new insights. This two-prong approach provides concrete methods and materials, evaluate, and develop techniques, and identify future needs for firefighting equipment and training.

Furthermore, the project has increased the awareness of the complexity of EV traction battery fire, and the need for both short- and long-term solutions and addressing fire safety issues, which potentially could slow or hinder the fulfilment of government policy goals in the Nordic region. Through a broad involvement of partners, the project focuses on anchoring results and making them immediately useful in the maritime sector. This will help to facilitate safer EV travel across Denmark and throughout Europe, with reduced risk for potential fatalities and property damage.

Finally, the project provides a foundation for stakeholders in the maritime industry in Denmark - and Danish companies manufacturing detection and suppression technologies at the forefront of the development of EV fire safety at sea.

1 ELBAS – WP1: Human Factors

DEN DANSKE
MARITIME FOND



The Danish Maritime Fund –
Project number 2021-039

1.1 Introduction

The following chapter describes how Human Factors can affect the firefighting capabilities at sea and how the shipboard firefighting crew may be affected by the technology at their disposal and their surrounding environment including passengers.

1.2 Methodology

The following section describes the methodologies used during the research and data gathering phase of the ELBAS project for the Human Factors workshop. DBI acquired the data through a series of interviews with ships' crews held over multiple trips sailing through Danish and Norwegian waters. During these trips, DBI also observed the day-to-day activities of individual crew members and fire drills to understand how the crew trains for a live situation. In addition, DBI conducted a literature review focused on human factors in maritime and electric vehicle accidents.

1.2.1 Literature Review

DBI conducted a literature review at the early stage of the ELBAS project to get insights into previous accidents related to electric vehicle (EV) fires. The review was a typical desk set-up research and included accident reports from the Danish Maritime Accident Investigation Board (DMAIB). The human factor review consisted of two parts, one focusing on EV fires and one focusing on human factors in maritime accidents.

The only accidents studied were related to passenger-carrying vessels, limiting the scope of the review, and focusing on the ship types included in the ELBAS study. Conveniently for this project, an accident report was available on a prior incident onboard the PEARL SEAWAYS which took part in the ELBAS study. This incident involved an EV fire in 2010. Although this fire event occurred 12 years prior to the writing of this report, it provided valuable information on how the crew acted to bring the ship back safely to port.

DBI also reviewed literature released by land-based authorities and actors with experience in dealing with electric vehicles on land. This review proved to be especially useful in understanding how ideal EV firefighting may happen. Additionally, peer-reviewed popular articles on human factors in maritime accidents and risk assessment and control were reviewed for this project. Literature on EV fires and the human and organizational matters surrounding these events were also studied.

1.3 The Ships

Three ships from three Danish ferry companies were visited, and their crews were interviewed for the ELBAS project. The ships vary significantly in age, size, and service different routes of varying distances. The three types of ferries included; an overnight cruise-ferry, a high-speed ferry, and a Ro-pax day ferry.

1.3.1 PEARL SEAWAYS: Overnight Cruise-ferry

PEARL SEAWAYS is an overnight cruise ferry, and was formerly the PEARL OF SCANDINAVIA and was originally delivered as the ATHENA to a finish owner in 1989. Taken over by DFDS in 2001 for their Copenhagen-Oslo route, the ship is Denmark's largest passenger ship. As of June 2020, her route also includes a stop via Frederikshavn, Denmark. In addition to being the largest passenger ferry in Denmark, PEARL SEAWAYS is also one of the largest hotels in Denmark, with 703 cabins and a capacity for 1,832 overnight passengers.

PEARL SEAWAYS was initially built for use in Viking Line's Baltic Sea traffic and was the world's largest car ferry at the time of commissioning. When the shipping company faced bankruptcy in 1993, the ship was sold

to the Malaysian shipping company Star Cruises. Star Cruises converted the ship into a casino cruise ship to sail from Hong Kong and Singapore. During the time in Asia, the ship's new owners extensively upgraded PEARL's camera system for security surveillance purposes. Today this surveillance system provides the crew with an excellent view of potential fires from the bridge.

PEARL SEAWAYS has several restaurants, indoor and outdoor bars, pubs, conference rooms, an auditorium, spas, and cafes. The passengers onboard PEARL SEAWAYS range from cruise passengers going on what DFDS calls a *'Mini-Cruise'* with two nights at sea and a few hours in Oslo to passengers sailing between Norway and Denmark for business and travel. This mix of passengers can provide additional challenges for the crew in the event of a fire. Passengers travelling regularly on PEARL SEAWAYS may be well acquainted with the vessel, while other mini-cruise passengers are less likely to know their way around. Additionally, there is the risk that some passengers may be affected by alcohol, given the cruise vacation atmosphere onboard, which could have an effect on how well the passengers act according to instructions in case of an emergency.

1.3.2 EXPRESS 4: High Speed Ferry

EXPRESS 4 is a catamaran high-speed ferry delivered to Molslinjen in 2019 and has a capacity for 1006 passengers. The ship operates on the route between Aarhus (or Ebeltoft) and Odden, Denmark. As the EXPRESS 4 operates on a shorter crossing, the ship does not have overnight accommodation for passengers sailing onboard. Instead, passengers spend time in the ship's lounges, where food and a large seating area are available.

The EXPRESS 4 is the fastest vessel of the ones examined in ELBAS, capable of reaching speeds of 40.5 knots (75 km/h). The types of passengers sailing onboard EXPRESS 4 are typically persons who need a quick route to go from Jutland to Zealand in Denmark, without passing the longer way over the island of Fyn, saving drivers up to 200 km compared to the journey by road.

1.3.3 COPENHAGEN: Ro-Pax Day Ferry

The COPENHAGEN is a Ro-pax day ferry, delivered to Scandlines in 2016, and sailing on the Gedser - Rostock ferry route between Denmark and Germany together with her sistership, BERLIN, and has a capacity for 1,300 passengers.

Passengers sailing onboard COPENHAGEN usually do so because of travel, either for business or pleasure. A portion of the people sailing onboard COPENHAGEN are also same-day return border shoppers, taking a shopping trip to Germany.

1.4 Qualitative Interviews

The most significant portion of data and insights DBI gathered came from interviews conducted while sailing around Danish and Norwegian waters. Unfortunately, the interview study was met with a problematic start causing it to be delayed by a few months due to the outbreak of COVID-19. These disturbances meant cancellations and postponements during the initial interview stage, resulting in less-than-ideal interview settings in the early phase. Sailing finally began in March of 2022. Members of the project team spent three days onboard the PEARL SEAWAYS conducting interviews with most crew members, including fire watches, hotel staff, restaurant staff, crew, officers, and the captain. These interviews were soon followed up with similar interviews onboard the COPENHAGEN and EXPRESS 4. All the shipping lines involved in the interview

phase, DFDS, Molslinjen, and Scandlines, were constructive and eager to provide helpful input that could aid the firefighting in electric vehicles.

The line of communication formed will continue beyond the conclusion of this project in an active effort to reach out and involve more stakeholders in the industry. Talks with stakeholders in 2023 are scheduled, and DBI hopes these meetings and interviews will provide further insights to continue building the foundation for future projects on this topic.

In addition to these interviews, a large workshop with attendants from land-based authorities, maritime authorities, equipment manufacturers, firefighters and ship crews allowed us to broaden the investigation of electric vehicle fires beyond the sea. The workshop showed how to extinguish fires in cramped conditions, such as a ship's vehicle deck, using different types of equipment.

1.4.1 General Attitude Towards Fire Safety

The crew on all three ships were observed to be well-trained and having a solid dedication to safety. No uncertainty of individuals' roles onboard during an emergency ever came up. The interviewees spoken to by DBI personnel knew their responsibilities well, and their knowledge of firefighting was high. Each of the shipping companies have put great effort towards knowledge sharing and increasing awareness of electric vehicles and battery fires. Due to a lack of easily accessible information on EV fires, the crew asked many questions about the dangers of battery fires. This has led to increased attention to the hazards of batteries onboard.

1.4.2 The Bridge

From the bridge of all three ships, it was easy to get an overview of the ship's fire alarm systems.

The closed-circuit tv (CCTV) camera coverage of the vehicle decks was excellent, and it was easy to get an overview of the vehicles. It might even be possible to identify vehicle types from the bridge via the CCTV system. This monitoring capability may prove helpful in fighting fires in electric vehicles on the vehicle deck.

From the bridge, the following functions can be operated to aid with firefighting:

- Ventilation
- Pumps
- Surveillance
- Fixed fire extinguishing systems (Drencher system (Except for PEARL SEAWAYS))
- Communications

It should be noted that because of the different dates of construction (keel laid dates) of the ships, they are not all expected to have the same functionality. All three ships comply with the minimum requirements for their type and sometimes go beyond that in the form of additional equipment.

1.4.3 The Vehicle Deck

The vehicle deck layout is different from ship to ship. The high-speed ferry is open fore and aft, while the Ropax day ferry has one upper vehicle deck which is open at both ends and one fully enclosed vehicle deck. The cruise ferry has one large enclosed vehicle deck, with hanging car deck that can be raised and lowered as required. All three ships are equipped with CCTV cameras to enable the crew to get a good view from the

bridge. The statutory required equipment available for firefighting was the same across all three ships. All the shipping companies are considering additional equipment to aid in firefighting of EV fires, and all three ships had different approaches to fighting EV fires.

1.4.4 Fire Watch

Each ship has a procedure for having a crew member designated to conduct a fire watch, in order to detect a fire before it develops. This crew member makes their rounds on the ship to ensure that everything is safe. Depending on the ship arrangement, the time of day, and which areas are manned, the route for a fire watch may vary.

During the observation of one of these watches, it became clear that the crewmember had a very good knowledge of the ship, and which areas that could potentially be problematic. This is not only related to fires on the vehicle deck, but also fires in general. When going a night patrol route on a larger vessel, all the main corridors, restaurants, galleys, public areas, vehicle decks and more, will be checked for anything considered *'out of the ordinary'*. If a fire should be discovered on this route it is often discovered so early that a smoke detector would not have set off an alarm yet. This means that the fire watch will often attempt to extinguish a fire if observed before calling for assistance. Whether or not the watch will call for assistance depends on the severity of the identified fire.

1.4.5 The Catering and Hotel personnel

Some of the catering and hotel personnel were also trained maritime firefighters and the permanent staff were very knowledgeable. In case of a fire on the vehicle deck, the catering and hotel personnel were tasked with making sure that the passengers and crew are taken care of and evacuated if need be. If catering and hotel staff were trained as firefighters, then they aid in the extinguishment of fire and may be sent to the vehicle deck.

Onboard all three ships, there was a considerable number of seasonal staff or student workers making up a large portion of the restaurant personnel. This means that seasonal workers may not be as well informed about procedures in case of fire and may not be able to assist in case of an emergency at the same level as an experienced crew member. It should be noted, however, that even though these seasonal and student employees are not as experienced as the permanent crew, they still participate in the weekly fire drills held onboard. These considerations for catering staff also apply to the hotel staff.

1.5 Procedures when a Fire Occurs

The initial procedures for what to do when a fire occurs onboard the three ships are almost identical. Depending on the type of ship and the type of fire, the procedures will then begin to differentiate. On each ship there are different concerns either due to the proximity to the nearest port, the time of day, or the design of the vessel.

1.5.1 Verifying the Fire

A fire on a vehicle deck will often trigger a smoke detector and send an alarm to the bridge. As soon as an alarm goes off the personnel will begin to identify which detector was triggered and verify that there is a fire by using the ships' CCTV cameras. It may be the case that there is no visible smoke or that the fire has not developed far enough to show up on the camera. If that happens the crew must go to the vehicle deck to

verify that there is a fire. Smoke detectors triggering is not uncommon, so it frequently happens that personnel must go to the vehicle decks to verify that a fire has started.

After verification the personnel will report back to the bridge to confirm that a fire has developed, and firefighting must begin. The general order of actions is:

1. A smoke detector gets triggered.
2. The cameras are checked for confirmation that a fire has developed.
3. If the CCTV cameras provide no evidence, personnel are sent to the vehicle deck.
4. Personnel reports back to the bridge and appropriate actions will be taken.

1.5.2 Ventilation

Due to the toxicity of the smoke from a fire, the procedure for how to handle ventilation was discussed internally at the time of this project.

The standard procedure for ships such as the PEARL SEAWAYS has historically been to turn off the ventilation to attempt to smother the fire and assist in the firefighting together with the drencher system. This procedure was discussed during a debrief onboard, due to the potential toxicity of the smoke released from modern car fires.

As for the high-speed ferry and the ro-pax day ferry, ventilation would be turned on and ship would be turned in such a direction that smoke would be led away from the ship keeping the passengers safe.

1.5.3 Fighting the Fire

When fighting a fire on the vehicle deck there are multiple firefighting strategies which can be used, but the shipping lines mostly agree on one thing; the fixed firefighting sprinkler system (drencher or water mist) should be activated as soon as possible. The fixed sprinkler system is the first line of defense, in case of a car fire and enables the crew to fight the fire remotely.

When hours away from the nearest port, such as onboard the PEARL SEAWAYS, considerations are made whether manual firefighting is needed. The PEARL SEAWAYS is the only Danish ferry to have experienced an actual EV fire. When that EV caught fire, the ship's drencher system was activated, and the fixed system successfully extinguished the fire. Later, the fire crew went to the vehicle deck, to verify that the fire was extinguished and ensure that the fire would not reignite.

If it were the case that it was impossible for the drencher system alone to extinguish the fire, given the battery pack can sustain a fire by itself even when the drencher system is activated, then manual firefighting may begin. Depending on the conditions on the vehicle deck, the drencher system may be turned off, to avoid personal injury to firefighter from hot steam when entering the space.

For ships which are closer to a suitable port of refuge, manual firefighting can be avoided. This is due to the high reliance on the fixed sprinkler system as well as the shorter time it takes to get back to a suitable port where support can be had from professional shoreside firefighters.

The general rule in this scenario is to only enter the vehicle deck, in case need for evacuations of persons. The general order of actions is:

1. Turn on the fixed firefighting sprinkler system.
2. Send in shipboard firefighters to evacuate any persons on the vehicle deck.
3. Await to see the effect of the sprinkler system in controlling the fire.
4. Send in shipboard firefighters to control the fire after it has come under control.

1.5.4 Passengers

The passengers will be informed as the event unfolds to the extent needed. This is to maintain a good level of trust in the ship and crew, and to prepare the passengers for eventual further action needing to be taken.

If a vehicle fire is identified on the vehicle deck, then all passengers will be required to go to their muster point and await further instructions. This process is largely handled by restaurant and hotel staff.

1.5.5 Evacuating the Ship

If the fire cannot be brought under control, or the nearest suitable port cannot be reached, then evacuation of the ship may be required. In this scenario all ships will use their standard evacuation procedure and perform the action in as safe and controlled a manner as possible.

All the ships confirm that evacuation is considered an absolute last resort, and that the ship itself is its own best lifeboat.

1.6 Authorities

1.6.1 Land-based Firefighters

Regular contact with the authorities and land-based firefighters has provided a good insight into how EV fires are viewed. Just like at sea there are varying opinions on how to deal with EVs but there are some key points that all agree on being a challenge when a fire erupts. These points are:

- Heat generated from the fire
- Fire spread
- Toxic gasses released from burning vehicles

Going through the documentation released by the Danish Emergency Management Agency (DEMA) and hearing what they have to say about electric vehicle fires, it becomes clear that battery fires give rise to multiple dilemmas that differ considerably from responses to non-electric car fires.

In particular, the effort is different if it takes place in a closed environment, such as vehicle decks or parking basements. Due to the nature of a battery fire considerably larger amounts of water are required to cool the battery pack than what is otherwise required for non-electric car fires. As opposed to on land, at sea you have unlimited water, but it requires that the pumps must be kept running for longer to effectively fight the fire and considerations must be made for the surrounding environment.

DEMA lists the amount of water required to extinguish an electric vehicle battery fire to be up to 400 l/m. They also recommend a significantly larger number of firefighters for fighting the fire because the time of exposure should be kept at around 10 minutes.

With toxic gases being released from modern vehicles combined with the risk of re-ignition, extra caution must be taken to ensure the safety of passengers at sea.

1.6.2 Understanding Risks related to Li-Ion batteries

When dealing with a fire in EV, the recommendation from the side of the DEMA at the time of writing is that smoke diving should be carried out in the shortest possible time or not at all. The reason for this is that ordinary clothing for firefighting provided at sea may not provide optimal protection against substances found in the event of a fire in li-ion batteries. This concern may also be valid for other modern non-electric vehicles since the amount of plastic has increased gradually over the course of the last decades.

Any smoke emitted during a fire on the vehicle deck of a ship should be considered contaminated with particles harmful to health, especially if li-ion batteries from electric or hybrid cars are involved.

On a ship it is also essential to identify where smoke can spread to. Since most ferries have vehicles stowed on the lower decks below passenger accommodation, there is a risk that smoke and harmful particles can spread upwards to the passengers. The areas where smoke can spread must be identified quickly and efforts should be made to evacuate these areas.

1.6.3 Understanding risk in Relation to Smoke Diving on vehicle decks

With large spaces such as vehicle decks, there is also the risk that the shipboard firefighters may not have an overview of the progress of the fire in the entire extent of the space. Consideration should therefore be given to planning the smoke diving operation, so that all deployed personnel have clear and safe retreat routes and an understanding of any risks and restrictions.

It is understood that the Danish Maritime Authority takes the same approach to as the Danish Emergency Management Agency.

1.6.4 Firefighters – Experience and guidance from land-based emergency services

In the event of a risk of or ascertained fire/thermal runaway in an EVs, there are two types of interventions that normally are used according to the guidance from land-based emergency services. The choice of method used will be situational.

- Fire in electric car traction battery with offensive approach: Direct shutdown and cooling of battery.
- Fire in electric car traction battery with defensive approach: Let the electric car burn out or place it in an electric car container or equivalent with cooling.

In addition to the above, it will be possible to implement combination efforts, where an offensive approach is first used and then a defensive approach, e.g., in the event of a fire in an electric car in a building.

Defining the boundary of the fire incident scene and danger area - It is important to ensure that the danger area is large enough, so that emergency personnel who have not put on full respiratory protection are not exposed to smoke from the fire.

The same applies to the location of firefighting equipment and vehicles, regardless of whether the burning EV is located outdoors or in a building (/on a ferry vehicle deck).

In the event of a fire in an electric car traction battery, there are always several factors that the technical manager (on-scene commander), early in the response process, must make decisions about:

- Need for additional personnel, as the effort may risk being prolonged

- Fixed or continuous water supply
- Logistics around fire suits, compressed air devices, etc.

Furthermore, the technical manager (on-scene commander) must be aware of the risk of the effort developing, as the smoke generated from an electric car traction battery fire can create large amounts of HF gas.

The technical manager (on-scene commander) must include these elements in his considerations when the internal boundary is established and the structure of the incident site with its facilities is placed.

1.6.5 Precautions in the Event of a Fire in an Electric Vehicle

Common to both deployment methods are that, in most deployments, there is no immediate danger of the crew receiving an electric shock from the vehicle's high-voltage system. The battery and the electrical components are a closed system, which functions independently and is separated from the rest of the vehicle's construction. It is significant that the main switch in the electric car is switched off if this has not happened automatically.

The risk of electric shock only arises if the high-voltage electrical components have been damaged or a fire has occurred in the battery and direct intervention with these systems is undertaken as part of the firefighting strategy.

To minimize the risk of damage to personnel and equipment, it is important that the deployed personnel continuously assess the situation in relation to the development of damage and the current risks.

1.7 Summary of Insights

The following section is a summary of the insights presented in the chapter.

- The challenge of fighting fires in EVs and modern vehicles is a socio-technical problem, meaning that both people-oriented and technology-oriented aspects need to be considered, and which requires broad solutions beyond what can be delivered through technical solutions alone.
- The task of identifying the origin of the fire (battery or non-battery fire) is very difficult and should not be attempted until the fire is under control. It is better to assume the battery is ignited than not.
- Detection, combined with a good CCTV system is key to identifying and verifying a fire on a vehicle deck early.
- Having the ability to control all the ship's firefighting systems including the vehicle deck drencher system directly from the bridge can make a difference when having to react fast.
- There is a lot of uncertainty and worries concerning battery fires that need to be addressed to make people at sea comfortable by knowing and understanding what they are dealing with.
- Additional efforts should be put towards education and training for fires at sea. This includes both a practical understanding of the fire, as well as a theoretical understanding for those not directly involved in firefighting.
- Knowing the number of electric vehicles and the placement of these could be an advantage to firefighting in the short run. In the long run, EV sales predictions indicate that most vehicles at sea will be electrified.

- Decisions in relation to use of the ventilation systems are currently taken according to procedure or individual assessments on the bridge. An overview of predicted effects of smoke movement and ventilation behavior in case of a fire would be a good tool to aid in this decision-making process.
- Training on how to handle vehicles post fire is going to play a large role due to the risk of reignition in EVs.
- Added focus on the assistants to firefighters is important to the assistant's health. Correct disrobing procedures should be implemented to avoid contamination.
- Increase understanding of the various toxic gases to aid with awareness of potentially dangerous situations.
- Communication can at times be difficult to hear and or understand. Investment in modern communications equipment could help this issue.

1.7.1 Recommendations for Future Work

The following section focuses on recommendations for future work within the realm of human and organizational factors and their respective roles in EV fire incidents.

Interview more and a wider range of stakeholders – this is already ongoing and should continue after the end of the ELBAS project but should also be a feature of any future projects. The recommendation here would be to broaden the scope and include topics such as alternative fuels and other modern vehicles.

Future work and collaboration with selected industry partners, including ship-owners – this is also ongoing and will continue after the project. This will help with a greater understanding of the problem, getting more concrete with certain issues and solutions with selected partners.

2 ELBAS – WP2: Technological Aspects – Fire Scenarios and Technologies

DEN DANSKE
MARITIME FOND



The Danish Maritime Fund –
Project number 2021-039

2.1 Introduction

2.1.1 Objective

The overall objective of this report is to screen current detection and suppression technologies and methods for maritime and onshore use, presenting design criteria for effective firefighting of electric vehicle (EV) fires onboard ferries. The specific objectives are:

- Technology and methodology review, including detection and firefighting equipment, interviews with manufacturers and qualitative assessment of technologies.
- Description of fire scenarios based on literature reviews, stakeholder interviews (shipowners, land-based emergency services, etc.), visit to ferries, study of current procedures, description of ro-ro spaces and operational modes.
- Modelling of electric vehicles fires onboard of ferries in chosen fire scenarios.
- Summary of lessons learned that can be used for further investigating mitigation strategies and measures on ferries.

2.1.2 Summary

Current detection and suppression technologies onboard ferries may need to be supplemented, due to the specific fire hazards of EV (re-ignition, potential for jet flames, increased production of toxic gases etc.). It is therefore important to ensure early detection and early control of fire spread. Early detection of these scenarios however is not trivial, thus further large-scale testing of systems and collaboration with car manufacturers is the key to overcoming some of these issues. Hydrogen detection is one of the possible options that need to be further tested. Another option would be to take advantage of existing closed-circuit television (CCTV) cameras by combining them with fast detection algorithms. Several suppression technologies may be effective in preventing fire spread to neighboring vehicles and should therefore be tested (e.g., fire blanket, portable sprinkler system and direct injection system). It is also important to provide firefighting training for the crew when using new methods to suppress or extinguish the fire.

Fire simulations of two ferry types are presented in this report: two-tier vehicle deck on an aluminum high-speed catamaran ferry and a traditional enclosed vehicle deck with hanging car deck of a Roro passenger ferry. The effect of different fire locations, different storage arrangements, effects on the aluminum structure, effect of sprinklers and different ventilation conditions were analyzed. Ignited vehicle location, distances among the cars, different heat release rates, HRR curves, sprinkler impact, jet fans operation and general ventilation were investigated. The simulations show that detection times may be longer when the first car ignited is placed in vicinity of the ventilation extraction point, thus, placement of EV cars within the deck may be an important consideration. Further, the simulations showed that detection times depend on the heat release rate curve prescribed, as well as the car location. For the fire curve on EV tests taken from literature using a slow growth rate, the detection times were twice as long compared to a fast-growing design fire curve.

Ventilation of a vehicle deck during a fire showed positive effects on the open vehicle decks of the high-speed ferry in certain locations. Whereas, for the modelled closed vehicle deck arrangement, it was shown that ventilation can become detrimental after a very short time and therefore it is not recommended.

Simulations showed that exposed and uninsulated aluminum structures can reach critical temperatures above the fire, 5 to 18 minutes after the fire starts, depending on the fire location and time for activation of

the sprinklers. This can result in a structural failure or that a car falls on another deck if no cooling action is taken and the fire is allowed to burn. Insulation of the exposed ferry structure is therefore recommended. Early sprinkler activation is the key to stopping the fire spread, the procedures should be developed and simplified with that in mind.

2.1.3 Introduction

The increase of EVs on Danish roads is as a major step towards achieving full climate neutrality by 2050. However, while EVs have obvious benefits for decreasing CO₂ emissions, they present unique and complicated challenges when it comes to fire safety. Ferries offer the attractive advantage of transport over long distances, saving EV drivers both kilometers driven and giving them a potential time to recharge. However, with this increase of EVs comes the increased risk of an EV fire on-board maritime transport. This adds additional demands for shipboard firefighting capabilities, both in terms of training and materials. Since EV fires are already considered complicated to tackle on land, the requirements for successful fire containment and extinguishing at sea presents a pressing need for updating and developing current standards and methods, this is evidenced by several major projects besides ELBAS, notably: the European Union (EU) project LASH FIRE [1] and the German national funded project ALBERO [2].

The focus of this technical literature review is to address the specific hazards of electric vehicles aboard ferries. There are hazards from other alternative fuel vehicles (e.g., hydrogen fuel cell, natural gas vehicles, etc.), but because these vehicles are not as widely spread as EVs, the current analysis will be focused on the EV hazards. There are two key topics that the review will highlight: Early detection of a thermal runaway (TR) event and fire control methods.

General full-scale fire tests of EVs have been completed to compare the different fire phenomena between electric and traditional combustion engine vehicles [3 - 6]. In addition to these EV fire tests, the Research Institute of Sweden (RISE) has worked on two projects focusing on firefighting techniques in ro-ro spaces [7, 8]. Within the RISE projects were included EV fire tests. The National Fire Protection Association (NFPA) [9] has also worked on a project focusing on emergency response to incidents involving EVs. The NFPA project also included a few EV batteries fire tests. From review of all these tests, it was noted that the fire hazards for an electric vehicle have similar overall phenomena as an internal combustion engine vehicle (ICEV) but differ on several specific fire characteristics:

- Potential for jet flames to be projected from the sides of the vehicle as the superheated electrolyte gases eject from the battery modules.
- Increased rate of fire spread to neighboring vehicles (partially due to the jet flames)
- Slightly higher flame temperatures
- Increased production of toxic gases
- Reignition of vehicle after extinguishment of flaming combustion
- When the battery modules are involved in the fire, it is difficult to apply water directly to the modules.

These different properties of fires involving an EV make some of the traditional tactics for fire extinguishing ineffective. Thus, since there is no universally effective solution to these hazards, the existing methods and techniques need to be reviewed and updated. Additionally, the smoke toxicity aspect will be investigated.

2.2 Literature Review

2.2.1 Smoke from EV Fires and Toxicity

Smoke is a mixture of gases, aerosols and suspended solid particles, resulted from a burning material. Smoke from the burning of an ICEV is toxic and dangerous for health, as it contains CO, HF, HCl, SO₂ and small soot particles. Some gases produced (H₂, N₂, CO₂, methane, CO, HCN) are dangerous due to their asphyxiant action, i.e., these gases easily replace the oxygen in the air or prevent absorption of O₂ into the cells, causing unconsciousness. Others have acute irritant action, such as HF, HCl, SO₂, NO₂. Some studies indicate that the effect from irritants is more significant compared to the asphyxiant effect [10].

The use of batteries in an EV poses an additional source of potentially harmful substances generated during a fire. Smoke from EVs has been shown to contain more HF and some specific metals, such as Ni, Co, Li and Mn [6], compared to the smoke from ICEVs. This augments the health hazard for unprotected people present nearby, as hydrogen fluoride ion can be absorbed through the skin. In the blood it causes disruption in levels of calcium, potassium, and magnesium. The effects of inhalation and absorption through the skin may be delayed for 2-3 days [6]. Lecocq et al. tests showed that hydrogen fluoride yield can be 60% higher in EV compared to a conventional vehicle [5]. Others have reported dependence of HF measured on the type of battery and on State of Charge (SOC). Higher HF yield was noted in pouch cells compared to cylindrical batteries and batteries with lower SOC [6].

When Li-Ion battery ignites and releases toxic compounds, the knowledge of the rate of its release is crucial to fire safety and can indicate the time at which the amount of released toxin will pose health danger for humans. However, the amount of HF released depends on the condition of the battery, (i.e., electrolyte chemistry, SOC, charging state, battery configuration, etc.) thus HF concentrations can vary greatly. Several tests show this wide range of HF emission rates [10, 11]. Moreover, HF has a short half-life of 7 minutes and is easily absorbed by surfaces [6]. This means there is a lot of uncertainty involved in toxic gas release, which underlines the importance of early detection.

For early detection strategies it is important to note that before combustion, the battery releases a mixture of CO, CO₂, H₂ and hydrocarbons. The SOC of the battery has been shown to influence the gas yield. These gases have a lower flammability limit (LFL) at 6% and wider flammability range, thus posing an explosion risk. Tests have shown that a period of flammable gases release can vary greatly (from 15 to 40 minutes) without ignition, this brings uncertainty for modeling [6].

Additionally, toxic, and flammable gases can be generated when using sea water as a firefighting medium. Electrolysis of salt water, caused by water impregnating a compromised lithium-ion battery (LIB) pack, can form hydrogen gas and chlorine gas. The rate of generation of these gases is found to be higher than when using fresh water. This must be considered since salt water is used as the primary firefighting medium onboard ferries. This bares consideration since within the closed compartments of a ro-ro ferry the generation of explosive and toxic gases can, if allowed to build up, pose a risk for explosion. Additionally, the generation of these gases can continue after extinguishment if the battery stays immersed in salt water. This is especially the case if the battery has been destroyed or has exposed electrodes as this allows water in direct contact with its metallic components (Li). However, it is not recommended to remove the compromised batteries from the water. Instead, consideration for continued gas generation is important for

the responding fire crews. The cooling effect of the water is necessary to prevent the reignition of the battery pack.

2.2.2 Detection

When considering the fire risks of EVs, it is too late for fire prevention once a battery cell within the battery pack becomes compromised i.e., enters thermal runaway. Therefore, early detection is mission critical to reducing the overall fire risk. In the world of EVs, there are a variety of battery types, and more specifically electrolyte chemistries, which widens the scope of an idealized universal solution. An early sign of a potential thermal event within a battery is the off-gas event. When this event occurs, a small concentration of aerosolized electrolyte and vaporized electrolyte is released into the atmosphere. Off-gassing can occur when a battery is exposed to thermal, electrical, or physical abuse. However, the abuse type that has the highest likelihood of pushing a cell within a battery pack into an off-gas event is electrical abuse, specifically overcharging. It has been shown that monitoring for this off-gas event is still one of the better early detection options for predicting a potential thermal event. [12]

The key concern with this detection option is the different electrolytes used by the EV industry which produce a variety of species-specific gases. Baird et al. [13] presented an overview of vent gas composition for different battery chemistries and SOC, showing that hydrogen gas production may vary between approximately 3 to 45 percent of the volume fraction. This summary has shown that vent gases mostly consist of carbon monoxide and carbon dioxide, depending on the state of charge. However, using these gases for early detection may be problematic, as they are normally present within the atmosphere of a ro-ro ship loading and unloading cars. Instead, detection of hydrogen gas may be possible as an early detection method of a pre-thermal event. Temperature monitoring of the battery pack offers another method of pre-thermal detection. However, to do this externally (i.e., not from within the battery pack) gives some additional challenges due to the encapsulation of the battery packs. Detection options post-thermal event however are no different than traditional fire detection options: smoke/heat detectors, flame detectors, IR cameras, CCTV cameras, etc.

Aboard a modern ro-pax ferry, there are several mandatory fire detection devices. All fire safety requirements for ships are specified in their respective sections in SOLAS II-2 [14]. Since the focus of this review is on EV fires, the only area of the vessel that will be addressed is the vehicle deck. Primarily these areas are protected using a combination of smoke and heat detectors. The network of detectors is displayed on the navigation bridge on a monitor overlaying the plan view of the respective deck being monitored. In addition to the detectors, there are numerous CCTV cameras that give the navigation bridge live visuals of the accommodation and vehicle decks. If a detector alarm is triggered, the navigation bridge will be notified, and a response procedure will be followed. Additionally, as a precaution against ignition of flammable vapor build-up in closed ro-ro spaces an air change rate of 10 times per hour of the total air volume is normally required during the voyages. During the loading and unloading operations the flow rate is recommended to be increased to 20 times per hour. These ventilation conditions may impact the traditional and proposed detection and suppression methods.

According to SOLAS Chapter II-2, regulation 7, Detection and Alarm [15], smoke detectors are required in all stairways, corridors, and escape routes within accommodation spaces. The detectors shall be certified to operate in the smoke density between 2% and 12.5% obscuration per meter, when tested according to

standards EN 54:2001 and IEC 60092-505:2001. In essence any type of smoke detector may be used as long as you operate within sensitivity limits and avoid unsuitable environments for sensors.

All detectors installed on board ships must be of an approved type, and on European registered ships they must be 'wheel marked' according to the MED directive 2014/90/EU.

2.2.2.1 Point and Line Detection

Smoke detection can be point or line (beam) detection. There are many types of detectors: ionization smoke detectors (not allowed in many countries due to presence of radioactive material), optical, laser, temperature and multicriteria. A common type of detector is the optical smoke detector that utilizes LED light source. When smoke enters the detection chamber it scatters the light resulting in an alarm. This type of detector is good at detection of both flaming and smoldering fires and white/grey smoke. The downside of this detector is its sensitivity changes with time and questionable suitability for environment with car exhaust gases. Laser detectors have high sensitivity that can be adjusted and are less sensitive to dust particles. Multicriteria detectors use several detectors with the purpose of avoiding false alarms (for example, smoke and temperature detectors), but have a higher price. Optical and multicriteria detectors (combination of smoke and heat detector) are commonly used onboard ro-ro vehicle decks and thus need to be tested for their effectiveness for fires starting with EV batteries.

2.2.2.2 Full Room Detection Options

There are several different volume detection systems currently on the market. Active air sampling is a volume detection system that operates by monitoring both the current ambient conditions unaffected by applied hazards and within the hazard (monitored) area. A user defined tolerance is set for allowable gas or particulate species gradient between the two monitoring environments and if it is found to be more than the defined threshold the fire alarm control panel can be set to go to alarm. By using a floating ambient condition this helps prevent a false alarm, for example using a propane powered forklift in a warehouse monitored with this system can account for the exhaust of the forklift and raise the alarm limit. These types of detection networks can be set to a highly sensitive tolerance which may be useful aboard a ro-ro ship's vehicle deck.

Aboard most modern ferries there is a network of CCTV cameras. These cameras provide a multilevel of security monitoring. Within the realm of fire detection, these cameras provide confirmation of fire after a smoke/heat detector activates. An alternative approach uses the fixed CCTV cameras, which can be trained with AI or visual algorithms to detect smoke and/or flames [16, 17]. The sensitivity for detection can be adjusted to accommodate for transient conditions such as steam plumes generated by vehicle exhaust during cold days. Thus, specific cameras overlooking the ro-ro vehicle deck can be trained to monitor excessive smoke production from a vehicle or flaming combustion. This technology has been implemented within engine rooms and proven effective in detecting both smoke and flame. The downside of these converted detectors are visual obstructions since they operate through line of sight and the lack of a dedicated uninterrupted power supply.

Another volume detection technology that is used aboard ferries is UV/IR cameras, which are primarily used in the ship's engine room to detect flaming fire. The combination of UV/IR sensors is good for flame detection and avoidance of false alarms, however these detectors carry a significant price tag, and as such are typically installed only for protect the mission critical regions of the ship. Alternatively, these detectors could be an

option to monitor the ro-ro vehicle deck. The major concern with this detection option for battery fires is, however, the fact that once the flame in EV is detected it will be too late to prevent the thermal runaway.

2.2.2.3 *Vehicle Hotspot Detector*

As a part of the LASHFIRE project, a novel detection system has been tested in ro-ro spaces for hot spot detection prior to entering a ro-ro ship [18]. This method uses machine learning to analyze and provide real-time feedback on the heat signatures as a vehicle passes through. The conditions inside a ro-ro vehicle deck might be a challenge which has to be overcome for the system to be effectively used. Moisture, dust, and soot can reduce the performance of the detectors which requires a cleaner, brighter, and clearer atmosphere to perform best. This can be achieved by wipers and air flow barriers which are specifically designed for such detectors.

The sensors can be placed inside the ships or at the terminal. There are challenges for both locations such as weather conditions at the terminal and geometrical constraints if mounted on the ships. Regardless of the location, the sensors can be placed horizontally, vertically or as a combination of both. Once the sensors are mounted, for optimal functioning and operation of the sensors, the vehicle which is being checked should maintain a gap from the sensor without being too close or too far. However, more advanced but more expensive lenses with auto-zooming and focusing can be a solution for this issue.

2.2.2.4 *Discussion*

Ro-pax ferries, like all passenger ships on international or national trade, must meet statutory and class requirements with regards to fire protection, detection and extinction. However, with the new fire hazard of EVs, expansions in their detection capabilities are justified. An early sign of a potential battery failure is the release of hydrogen gas as the electrolyte within the abused battery vents decomposes. However, no significant testing was performed during this project investigating if an off-gassing event within an EV battery could be detected using a hydrogen gas detector external from the battery module. Specifically, a gas detector that is located well outside of the vehicle. The isolation of the battery cells within the battery module helps to protect the batteries from external abuse, but this configuration also prevents easily monitoring the battery with an early detection device.

If hydrogen gas detection is not a viable early detection option, then alternatives need to be addressed, in addition to the existing combination of smoke and heat detectors. A proposed compromise to existing detection methods is to take advantage of the large number of CCTV cameras aboard these vessels. As research into AI evolves and spreads into a variety of industries, this technology can be applied to provide intelligence to conventional devices. Applications of specific algorithms have proven effective for training CCTV cameras to detect flames and even smoke in some cases [16, 17]. If this technology can be proven equally effective as flame detectors, within the setting of a ro-ro vehicle deck, then instead of installing the expensive flame detectors the existing CCTV cameras can be a viable option.

Currently there are a limited number of charging stations found onboard ferries, and there is a serious pushback from shipowners due to the fire risk during charging [19]. In vessels that are already equipped with charging stations there is a potential to focus on early detection options along the charging distribution line. The traditional charging conditions aboard ferries involve carrying cables from the sides of the vessel, across and in between vehicles, to eventually arrive at the charging EV or reefer truck. EV manufacturers (Renault, Volvo, Tesla, BMW) prevent any transfer of data of the battery management system (BMS) through the

charging connection. Although no immediate specific data can be collected from the BMS from the charging connection this connection may be a helpful mounting location for a detection device: hydrogen gas, smoke, and/or heat. A base level of these conditions should be determined to see if this detection location is viable. This was investigated further in the ALBERO project [2].

2.2.3 Fire Extinguishment Methods

Fires involving EVs are, in general, more difficult to extinguish than conventional vehicles due to the properties mentioned in section 2.1.3. These properties hinder the extinguishing of the involved EV, increasing the rate of flame spread to other vehicles which increases the fire growth. Therefore, the worst-case scenario will need to be addressed, which is a fully involved EV fire.

2.2.3.1 Current Fire Extinguishment Technologies

The only area of the ro-ro passenger ship being addressed in ELBAS, regarding fire control methods are on the vehicle decks. Onboard a vessel there are several methods for controlling a fire event. For simplicity the methods can be better understood as two primary methods: manual operations and remote operations. The manual operations would consist of the firefighting tactics performed by the fire crews aboard the vessel. Specifically, the personnel in the fire crews involved with manual operations are those with the title of smoke diver. These shipboard firefighters are the personnel who use turnout gear, or Self-Contained Breathing Apparatus (SCBA), and physically fight the fire with their existing equipment and training. The minimum quantity and quality of the manual equipment on a vessel is specified in the applicable SOLAS [14] and MARPOL [20] requirements.

The manual operations focused on the shipboard firefighters who place themselves near the fire hazard. The remote operations are the additional fire crew members who place themselves away from the fire hazard and cascading fire effects such as smoke build-up. Their purpose is to assist the shipboard firefighters with external perspective, prepare tools for use, or operate the fixed fire control systems. These systems consist of the overhead deluge sprinkler system and the ventilation control system.

2.2.3.2 Fire Control Technology and Methods

When the entire EV becomes engulfed in fire, a proportional firefighting response would be expected. The safest response with the existing technology would be remote operation, for example the fixed deluge sprinkler system, which would allow to control fire spread if initiated in the early phase of the fire. The response described above is a preferred one, but there is some uncertainty as to whether the current sprinkler system is sufficient, therefore testing is recommended. It should be noted that most of the tools and tactics recommended here are applicable in specific cases (i.e., in the case of search operations, long trip to the destination at the time of fire onset, reduction of the water usage for stability related issues, etc.).

In review of the existing technology and fire hazard of EVs onboard ferries several fire control methods are proposed. These options can function together or individually and be rapidly implemented aboard ferries without legislative changes. Additionally, the options may not be a universal solution for all ferries but must be adjusted for each case respectively.

2.2.3.2.1 Increased Training on Manual Fire Fighting Operations

Focus on increasing training for the crews helps to address delays in fire response. Specifically, identifying an EV, responding to an EV fire [21], and fire containment tactics [22]. The intentions of advanced training on

firefighter tactics for EVs is to shorten the time for fire crew response and increase overall preparedness. This may also be considered relevant for all subsequent methods discussed.

2.2.3.2.2 Fire Blanket

A common fire control device for smothering small fires is the fire blanket. This technology has been improved to be an effective method to address EV fires. These EV fire containment blankets are typically made of proprietary materials to smother a fire. The blankets often come in dimensions roughly 6m x 9m and will fully cover most car type EVs. The blankets have built in handles so that firefighters can physically apply the containment blanket directly onto the burning vehicle. Recorded fire tests have shown effectiveness in quenching EV fires with limited exposure times for the fire fighters. These blankets have promising application onboard ferries due to their ease of mobility and effective prevention of fire spread to neighboring vehicles when correctly and timely applied.

There are concerns, however, about the ability of shipboard firefighters to effectively use this device onboard a ferry. The space available to work with on a vehicle deck is very different from the open parking lots used during fire testing. The reduced mobility onboard a ro-ro ship, along with potential snag points all around the work area may delay or prevent the use of this fire containment option. When communicating with manufacturers offering these products, the reduced mobility for this type of application is a valid concern and they recommend regular training [23]. Additionally, significant risks remain for overcoming roof mounted obstacles on EVs such as cross beams or cartop carriers. A possible solution for this is using multiple blankets and protecting the neighboring vehicles.

2.2.3.2.3 Li-Ion Fire Extinguishing Agents

There are two companies that offer agents specific for lithium battery fires, AVD [24] in the UK and Dafo [25] in Sweden. These systems function very differently regarding the interaction with the fire hazard, but both require direct application to the involved battery. The agent created by Dafo is called Forrex [25]. Currently, Dafo works directly with EV manufacturers and post-production vehicles to integrate early detection and fire extinguishing systems within the vehicles. Application of this agent requires an atomizing nozzle to adequately distribute the agent within the vehicle's battery compartment. Additionally, the system functions in combination with an early detection device [29] so that the thermal event has little time to develop.

The AVD agent, LithEX [24], stands for Aqueous Vermiculite Dispersion agent. This agent is made of a slurry of primarily water with a mix of vermiculate solution. When this agent is dispersed over the involved battery it cools the battery as the water evaporates. The vermiculite then forms an oxygen barrier over the batteries. High temperatures inside a battery will lead to oxidation of electrolyte and production of CO and CO₂. Therefore, AVD does not fully stop the process but may greatly retard it. In fire testing with lithium batteries AVD agent is applied directly to the cells or modules [26]. This direct application would not be possible for EV fires onboard ferries as the battery modules will be fully contained within the battery casing inside a vehicle. The two agents are promising fire control agents but without fire testing for EVs external to the battery module there are uncertainties on their effectiveness.

2.2.3.2.4 Mobile Water Mist System

Excessive water weight is a major concern onboard ferries and can cause unbalance and potential capsize on often already top-heavy ferries. A more water efficient option for firefighting, is to use a manually placed water mist system. This system would be an option like the ones seen in the ALBERO project [2]. The concept

could consist of two hose lines that feed separate mobile ground applicators (a stainless-steel pipe with specifically oriented water mist nozzles on it) that project a curtain of water around each side of the involved vehicle. This system has been effective in protecting the neighboring vehicles but not 100% effective in extinguishing the involved initial vehicle. This method of fire control method may work best in conjunction with an active smoke control system. The mobile water mist system can control the fire spread and growth while the excess smoke production can be extracted with the powerful ventilation system.

2.2.3.2.5 Direct Injection Systems

EV manufacturers do not recommend first responders to penetrate the battery module, but to apply water directly to exposed battery cells and open sections of the battery module [22]. Nevertheless, fire experimentation done by RISE has shown that direct injection of a cooling agent, be it water or an alternative fire extinguishing agent, is one of the most effective knockdown methods when dealing with EV battery fires [29]. Therefore, an electrically isolated direct injection device to flood the battery module with water may be an effective tactic in controlling the fire event within the battery module of an EV.

An example of a direct injection system is employed by the Rosenbauer Battery Extinguishing System Technology (BEST) [27]. This device penetrates the battery module in the correct area. The Rosenbauer BEST is a wheeled apparatus that is placed underneath the involved EV. The apparatus is connected to a hose line and a standard self-contained breathing apparatus (SCBA) and then it is ready to be used. The working principle of this apparatus is once in position underneath the EV the SCBA powers a pneumatic nail. Once the nail has penetrated the undercarriage into the battery pack, water begins flowing at 8 gal/min (30 l/min) at 100 PSI (6,9 BAR) to cool the battery. This is a novel concept that requires fire testing to prove effectiveness when implemented in a ro-ro ship. Identification of fire origin, and consistency in penetrating to the right depth to reach the burning battery cells may be potential issues to consider. The other concern with this method is that it can be costly, both in time and financial resources, it would require significant training for field applications, and risk increasing the fire hazard if an operator penetrates an uninvolved battery cell.

Another, more flexible direct injection system is an extinguishing e-lance with nozzles from Murer Feuerschutz GmbH [28]. It is designed to be used after the major EV fire is extinguished and there are signs of thermal activities in the battery pack. It is flexible because it is electrically isolated and equipped with different extension tubes allowing adjustments depending on circumstances. However, a sledgehammer is used to penetrate the battery with the e-lance tip. This requires both skill and strength to operate under very extreme conditions. Once the e-lance is placed securely into the battery pack the water can be allowed to run until the battery has cooled down sufficiently.

2.2.3.2.6 Water Submersion System

Submerging lithium batteries in water may not extinguish the fire if compromised cells have reached a thermal runaway event. However, this method will not escalate the hazard. This firefighting method is used onshore by fire brigades, where EV are lifted into a water filled container. Therefore, it is worth considering developing a rapid water submersion tank to surround the battery modules of EVs in water [29]. The concept of this fire control method is a quick field constructed water-tight barrier around the involved vehicle. It would consist of four barriers that can be placed around the vehicle, secured together, and filled with water to submerge the vehicle's battery module in water. This method is not intended to extinguish the EV fire, but it is meant to control the fire event and prevent the fire spreading to the neighboring vehicles. The concern

for this method is significant weight within a small area, but with the allowance of heavy machinery onboard the vessel it may not be a serious concern.

2.2.4 Recommendations and Conclusion

The recommendations and conclusions from the literature review are the following:

- ICEVs and EVs show similar total energy releases when experiencing similar fire scenarios.
- ICEVs and EVs fires vary with respect to smoke toxicity: EVs release higher concentrations of HF and some metals (i.e., Ni, Co, Li, Mn).
- ICEVs and EVs vary with respect to fire phenomenon: EVs can project jet flames and pose a significant risk of reignition, which significantly impact firefighting tactics.
- Further research and testing are needed for early detection methods of EV fires.
- Early detection and fast response by the fire crews is the key to controlling these fires safely.
- Taking advantage of existing CCTV cameras aboard combined with detection algorithms has some potential but needs to be tested onboard in a real setting.
- Advanced training of firefighter tactics for EVs is recommended to shorten the time for fire crew response and increase overall preparedness.
- Blankets and mobile sprinkler systems may be effective in preventing fire spread to neighboring vehicles when correctly and timely applied, but they should be further tested with regards to applicability in a ro-ro ship setting.
- Direct injection methods can be effective but need to be tested in a more realistic condition and if implemented requires in-depth crew training.

2.3 FDS modelling

Fire Dynamics Simulator (FDS) is a computational fluid dynamics (CFD) modelling tool that numerically solves a form of Navier-Stokes equations for low speed ($Ma < 0.3$) thermally driven flow with emphases on the heat and smoke transport from fires [30]. In this work FDS model is used as a tool to investigate chosen fire scenarios. FDS simulations allow the study of different scenarios which otherwise would not be feasible in a full-scale experiment. Once the model is set-up, any new fire safety solution can be tested.

A fire model is a simplified representation of an actual fire event, which means that there are several limitations and assumptions that must be kept in mind when looking at results. A list of limitations and assumptions is given in section 6.

2.3.1 Methodology

Methodology used in FDS modelling consists of several major steps, namely:

1. Categorization of Cars
2. Determination of Design Fires
3. Numerical Modelling of Cold Flow and Mesh Sensitivity Analysis
4. Numerical Modelling of Fire Spread
5. Conclusions

To represent different cars in a fire model simplification was needed. Cars were divided into 5 different categories based on an assumption that a car's calorific potential (i.e., energy) is proportional to its weight [4], see section 6.2 for the details.

2.3.1.1 *Design fires*

When a ferry vehicle deck of any arrangement is considered, it is possible for a fire to start on any type of car in any given location. However, it is time consuming and not feasible to try out all the possibilities during a numerical analysis. Therefore, it is important to select design fire scenarios which represent a possible high fire risk in the analysis.

The risk associated with EV fires can be higher in certain locations due to the geometry of the vehicle deck and ventilation system used. The geometry or the layout of the vehicle deck might make it difficult for a vehicle to be taken out or even reach the fire seat. Some of the zones within the deck might become recirculating zones or “dead” zones depending on the ventilation parameters leading to slower detection times and localized smoke accumulation. In addition, charging vehicles using an on-board charging station can also be considered as a high fire risk situation and the nearby area can be considered a high-risk area.

All the above details allow the analysis to be focused more on the identified areas rather than running simulations using random locations within the deck. Therefore, the layout of the vehicle decks, ventilation, charging stations and other such details which increase the risk of fire will be considered. The design fires for the analysis are selected based on the above reasoning and several scenarios are selected for two different vehicle decks.

2.3.1.2 *Cold Flow Simulations and Mesh Sensitivity Study*

As mentioned earlier, ventilation systems used inside the vehicle deck play a key role in the initial detection times and the smoke dynamics inside. Furthermore, it is also important that when the first car is set for ignition that the flow conditions inside the deck stabilize.

Before the introduction of combustion into the numerical model, it is important that the fire scenarios are established. To identify the possible dead zones or recirculation zones, the initial flow field is simulated using only the ventilation system activated (“cold” simulations). This preliminary analysis shows the time required to reach the steady conditions and the dead or recirculation zones, which can cause potential collection of hot gases.

Once this step has been completed, the mesh sensitivity analysis is performed using a simple scenario to test the accuracy of the calculations and find an optimum mesh resolution for the final analysis. The same scenario is modelled using different mesh resolutions, and the results are compared. The selection of the optimum resolution is done based on the accuracy of the results and computational cost for each resolution. Thereafter, chosen design fires are run using the desired optimum cell size selected in this step.

2.3.1.3 *Numerical Modelling of Fire Spread*

The modelling of fire spread between vehicles is dependent on many factors such as: ignition temperature of the first material to ignite, distance between the vehicles, type of the adjacent vehicle and geometrical features.

When a vehicle catches fire, it is often the tires or the polymer window seal or bumper which catches the fire first [31]. Both components are made of polymers, therefore the ignition temperature of rubber has been chosen as the threshold for catching fire and producing flames in FDS which was set to 250 °C. More studies are required to determine the ignition temperature of the material that is likely to ignite first. The value of fire spread was determined after investigating several values with the aim of reaching a heat release curve

closer to the desired one. The value of 0.01 m/s was found to be a satisfactory assumption with regards to the fire spread in ro-ro vehicle deck.

2.3.2 Fire Scenarios

Simulations of two ferry types are presented in this report: a two-tier vehicle deck of aluminum high-speed catamaran ferry based on the arrangement of the EXPRESS 4, and a fully closed vehicle deck with a retractable hanging car deck as on the PEARL SEAWAYS.

2.3.2.1 EXPRESS 4

EXPRESS 4 is Molsslinjen's newest high-speed catamaran ferry, with an all-aluminum construction which has the capacity for 1006 passengers and crew, 425 parking spaces for cars on the vehicle decks and 610 m of truck lanes. The high-speed ferry sails at a speed around 37 knots (70 km/h) when loaded and is 109 m long and 30.5 m wide. Due to the high speed of the ferry, the journeys from Odden to Aarhus and Odden to Ebeltoft can be completed within 75 minutes and 55 minutes, respectively. The EXPRESS 4 is built of aluminum, which makes the ship potentially more vulnerable to the effects of a fire; However, EXPRESS 4 is constructed to and meets all of the statutory fire safety requirements for such vessels, and the ship never sails far from a port.

The ferry has 4 decks with the lowest two decks being the two vehicle decks. The third deck accommodates a seating area for passengers, a restaurant, and a coffee bar.



Figure 2.1: Locations of the vehicles ignited first in different fire scenarios on tier 1 and tier 2 of Molsslinjen EXPRESS 4

The two open ended vehicle decks sit just above the twin hull structure of the ferry, see Figure 2.1. Truck lanes are only available on tier 1 which is the lower deck. This deck is also equipped with a charging station which can charge two vehicles at once, using only the 10 m cable provided onboard. Tier 2 is only allocated to smaller vehicles, excluding larger height vehicles such as container trucks. The ceiling heights of tier 1 and tier 2 are 4640 mm and 2140 mm respectively. The two tiers are connected via an internal fixed ramp which is also made of aluminum. Smoke detectors, heat detectors and flame detectors are present on both decks covering the whole area including the area under the ramp. Both decks are also equipped with a sprinkler system which can be activated manually in case of fire.

Before simulating a fire scenario with multiple vehicles on the decks, simulations without fire and simulations of single car fires were run to analyze the flow field within the decks and for the mesh sensitivity study (see section 6.) Several simulations were run representing different fire scenarios which are tabulated below in Table 2.1 with locations explained in Table 2.2 and shown on Figure 2.1. A detailed analysis of these simulations is presented in section 6.8.

Table 2.1: Initially ignited vehicles for different fire scenarios

Tier 1	Charging station – near wall	Location 1 (L1)
	Charging station – central	Location 2 (L2)
	Near air output	Location 3 (L3)
Ramp	On the ramp	Location 4 (L4)
Tier 2	Near air intake	Location 5 (L5)
	Near air output	Location 6 (L6)

Table 2.2: Summary of fire scenarios for Molslinjen

Tier	Location	Distance between cars	Jet fans (on/ off)
1	Charging station – near bulkhead	40 cm	Off after detection
1	Charging station – near bulkhead	60 cm	Off after detection
1	Charging station – near bulkhead	Single car	Off after detection
1	Charging station - central	40 cm	Off after detection
1	Charging station - central	60 cm	Off after detection
1	Near air out	40 cm	Off after detection
1	Near air out	60 cm	Off after detection
Ramp	On the ramp	40 cm	Off after detection
Ramp	On the ramp	40 cm	On
Ramp	On the ramp	60 cm	Off after detection
2	Near air in	40 cm	Off after detection
2	Near air in	40 cm	On

2	Near air in	60 cm	Off after detection
2	Near air out	40 cm	Off after detection
2	Near air out	60 cm	Off after detection

Several variables were varied in simulations described above: location of the initially ignited car and distance between the vehicles was varied between 40 cm and 60 cm. Additionally, jet fans were either switched off or switched on to see the impact on detection time and visibility.

2.3.2.2 PEARL SEAWAYS

MS PEARL SEAWAYS was built in 1989 initially for Viking Lines and later refurbished back into a car-passenger ferry for DFDS. It currently operates between Copenhagen and Oslo with a stop in Frederikshavn. In 2010 the ship experienced a fire in an EV left charging onboard located in the aft on the port side [19]. After the fire she was refitted and given its current name. The vehicle decks consist of two decks (deck 3 and 4), where deck 4 is a hanging car deck, which is accessed via a ramp that can be lowered down, when needed. The models of a closed vehicle deck used in ELBAS are based on DFDS's PEARL SEAWAYS layout and geometry. Dimensions precision when modelling is dependent on the size of the largest mesh chosen (i.e., in this case a mesh of 20x20x10 cm was used). See the mesh sensitivity analysis for further details in section 6.7.2.

When a fire is detected onboard PEARL SEAWAYS, the ventilation is switched off manually. The time to ventilation shut down will depend on the situation and decision times of people in charge. Generally, the crew has two minutes to react before an alarm sound goes out to the passengers. Therefore, this time of two minutes is used in the current simulations to close the ventilation. Closing of the air exhaust vent is done using a ramp function in FDS. Moreover, only the largest central air intake openings are closed at the same time, keeping few smaller openings left, assuming that the vehicle deck is not completely airtight. All these actions are undertaken to avoid the creation of pressure changes that may result in numerical instabilities in the simulation. Additionally, a system of jet fans is installed on the vehicle deck, but it was used once during construction works and since then has been obstructed by ceiling installations, deeming it useless for smoke control purposes.

Distances between the cars onboard a ro-ro ship vary depending on the number and types of cars being loaded. According to the internal rules at PEARL SEAWAYS, when stowing and securing vehicles onboard, the recommended distances between the stowed cars are: 100 mm between the extremities of the car, 300 mm between the bumpers and 200 mm between a car and any fixed object. It was found however that these distances can often vary as smaller or larger spacing. In FDS simulations the distance choices are mesh dependent. (The mesh sensitivity analysis in section 6.7.2) and concluded in the distance between bumpers being set to 20 cm, due to distances of 25 cm measured onboard. Between neighboring cars two different distances were tested: 20 and 40 cm.

Simulations for the PEARL SEAWAYS cases were varied in respect to the choice of ignition Heat Release Rate (HRR) curve, distance between the cars in the lanes, position of the car for ignition, ventilation, and sprinkler activation. Additionally, assignment of HRR to the cars besides the ignition car was done using a randomization algorithm. Based on the categories described in section 6.2, the HRR curve for EV vehicle to be first ignited was designed based on the car weight categories and compared to HRR for a full-scale EV vehicle test. These comparisons are detailed in section 6. In simulation 40_5, the ventilation was kept at 20

m³/s. After the fire started, it was activated to full capacity at 56.94 m³/s to see the impact on smoke dynamics.

The modelling of sprinklers is challenging, and it is still not a well-validated capability in FDS. Hence, potential impact of sprinklers in the simulations 40_6 and 40_7, shown in Table 2.3. These simulations were modelled with so called freezing of HRR. In freezing of HRR it is assumed that the HRR will remain constant after the activation of deluge system, representing the sprinklers impact on preventing further fire growth. The two cases represent the estimated time interval for sprinklers activation, where the time to activation and minimum/maximum reaction time were accounted resulting in freezing of HRR after 337 and 537 seconds, respectively.

Table 2.3: Summary of fire scenarios for PEARL SEAWAYS

Simulation ID	Description	Ignition car, peak HRR [kW]	Distance between cars [cm]	Car position [zone]
20_1	Distance between cars 20 cm	10441	20	1
40_1	Distance between cars 40 cm	10441	40	1
40_2	Ignition in zone 2	10441	40	2
40_3	Ignition in zone 3	10441	40	3
40_4	Test fire curve	7069	40	1
40_5	Ventilation on	10441	40	3
40_6	Sprinkler – 5 min	10441	40	2
40_7	Sprinkler – 10 min	10441	40	2

Cars are placed in zones shown in Figure 2.2 below. In zone 1, the ignition car is in the corner under the deck, in zone 2 and zone 3 the ignition car is surrounded by other cars from all sides and located under the ramp.

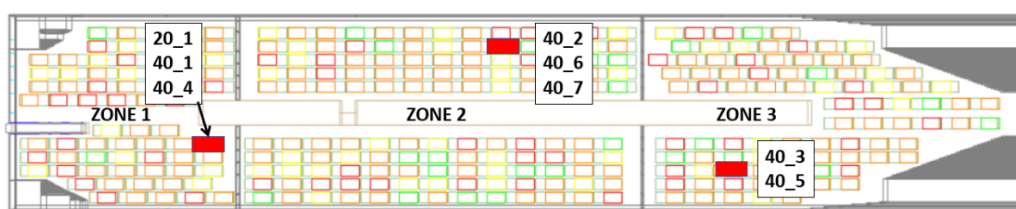

Figure 2.2: Positions of the cars for different fire scenarios in zones 1, 2 and 3 are marked red. Location of the car is marked with corresponding fire scenario numbers.

2.3.3 Simulation Results

Simulations can be very useful to identify issues and behavior of fire and smoke, but the results of such simulations are dependent on the geometry. The results presented below are based on the two case studies of ships and, therefore, any generalizations should be done with care. There is a need to perform this type of study more often to better quantify and inform owners and the crew of the specificities of their ship. Detailed description of simulation analysis can be found in section 6. Below, only the conclusions for respective ship type are presented.

2.3.3.1 EXPRESS 4

The effect of different fire locations, different parking arrangements, effects on the aluminum structure and different ventilation conditions were analyzed from the simulations run for different scenarios. Ignited vehicle location, distance between the cars and jet fans operation are the parameters that were investigated. The scenarios modeling flame spread did not have the sprinkler system (drenchers) on the vehicle deck activated. This was chosen in order to examine the 'worst case' fires scenarios, modeling smoke and flame spread, and temperature rise.

Fires starting near the aft air outputs of the two decks showed longer detection times compared to other locations due to the layout of the detection system and the natural flow pushing the smoke away from the detectors nearby. In all cases the time taken between the detection and the time when flames spread to a second vehicle were much lower than the 10 minutes requirement for the crew to gather and prepare for the firefighting. The time for the fire spread to the next car varied from around 2 to 7 minutes.

Increasing the gap among cars from 40 cm to 60 cm resulted in longer fire spread times to an adjacent car, but with similar detection times for all the cases. This increased the time interval for the crew to gear up before the flames ignited the second car from around 3 to 8 minutes. This shows the importance of evenly distributing the cars on the two decks, especially during the low seasons, hence having a larger distance between the cars.

Keeping the ventilation system turned on during the fire, seems to have a positive effect for the fires occurring in the higher deck (tier 2). While for fires occurring on the ramp and on the lower tier 1 seem to benefit from just the natural air flow, without the need of jet fans. For the fires in tier 2, the jet fans were able to clear smoke and gases out and provide a path to the fire seat from tier 1 via the ramp to tier 2.

In some of the simulations performed, the exposed, uninsulated deck plating of tier 2 reaches unsafe temperature at around 5 minutes into the fire with a fire occurring on the fixed ramp forward and could lead to a structural failure of the mezzanine deck (tier 2), when the sprinklers are not running. For fires in tier 1, the structure of the mezzanine deck takes around 18 minutes to reach these temperatures by which time, the crew should be able to reach the fire and cool down the surroundings. A failure in the mezzanine deck should not affect the whole superstructure. On the other hand, it could cause a car to fall from tier 2 to tier 1, which can lead to complications. This could potentially be avoided, by placing insulation covering the exposed area and ensuring that the sprinkler system is actively cooling. In all the cases, the deck flooring of the passenger deck never reached untenable temperatures and the insulation was effectively providing protection throughout the fires.

2.3.3.2 PEARL SEAWAYS

Chosen scenarios have shown that flame spread is dependent on location of the ignited vehicle. This can give an indication for a location of charging station or a zone for EV storage. Simulations showed that keeping the ventilation on during the fire can be dangerous if the deluge system is not activated within the first 10 minutes of the fire duration. The reason for this is that in the tested fire scenario ventilation was able to control a smaller fire for a short period of time, but once the fire spreads ventilation served as an oxygen supply and could not evacuate the smoke produced. Therefore, having ventilation on for the whole duration of the fire is not recommended.

The detection times for design fire curve (10,441 kW) are in order of 30 seconds, changing slightly depending on the ignition car placement. With test fire curve (7,069 kW) the detection time can be over 1 minute. It can even take a longer time because the test fire curve in this scenario was modified and the starting stage with extremely low heat release rate was cut out. This shows the need for alternative early detection methods. If sprinklers are activated within 5 minutes from the fire start in the right zone, then the fire can likely be contained for these types of fire scenarios, as it was observed in simulations and in live fire tests that in worst case scenario a fire can spread from one car to another in about 5 minutes.

The most favorable conditions can be created using early activation of the sprinklers in the fire location. It is important to be able to see the sequence of smoke detectors activation, especially for a decision on which of available zones to activate when a fire is detected in the middle of the ship (zone 2). It is possible to activate two sprinkler zones at a time. Nevertheless, to fully control a fire in zone 2, an activation of 3 sprinkler zones is required, detailed further in section 6.7.2. Whereas a fire in zones 1 or 3 can be fully controlled by two zones, assume that sprinkler activation is done at an early stage (5-10 minutes after the fire starts). This shows the importance of making sure that in case of a fire, the smoke detectors activation order is clear to the decision takers.

The placement of the cars with as large distance as possible also gives a time advantage. In the scenario when cars were stowed 20 cm from each other the second car ignited after 4.3 minutes and for distance 40 cm ignition occurred at 7.3 minutes. This gives approximately 3 minutes delay in fire spread to the second vehicle when cars are stowed at 40 cm compared to 20 cm, valuable time for the crew to react. The position of ignition vehicle in the aft based on the current scenarios is a favorable condition, both due to difference in a fire spread and better ability to control the fire. Nevertheless, a fire in 2010 may have happened in a most favorable location but was unfortunate to spread to a heavy vehicle placed nearby and to the other side of the nearest flood door (zone 2) due to the late sprinkler activation over the ignition source [19].

Tenability conditions are the conditions (such as smoke layer height, temperature, visibility) that are predefined to designate the available safe egress time (ASET). These conditions are specified for spaces where egress time for unprotected people is relevant. In the case of vehicle decks, no passengers are allowed for the whole duration of the trip. Tenability conditions in this case can be defined to see whether the crew can safely enter the space and/or reach the seat of fire. If the crew must enter to manually fight a fire on the vehicle deck, an entrance/exit in the aft is not recommended due to the steep staircase that in a stressful situation with heavy equipment may cause an injury. The optimal places are the entrances in the central part. Nevertheless, these entrances are not directly connected to each other and demand experience of being able to find a way up and down the stairs and past the cabins. It is then of high importance to identify the first detection locations to predict which direction the smoke will be spreading the most. For example, if the fire has started in zone 1 and no time is lost (fire is controlled within 5-10 minutes by drenchers), then the crew may consider using the closest exits. If the fire has been ongoing for more than 10 minutes, it would be safer to enter through the further exits, considering on which sides the fire has started.

2.3.4 Recommendations and Conclusions

The recommendations and conclusions presented below are based on the two case studies presented in this report, any generalizations should be made with care. There is a need to perform this type of study more often, to better quantify and inform owners and the crew of the specificities of their ship. Results presented

in this section are based on the detailed analysis outlined in greater detail in section 6 (WP2 Appendix: Technological Aspects - Fire Scenarios and Technologies).

- Detection times may be longer when ignition car is placed in vicinity of ventilation outlets on Molslinjen. Thus, specific placement of EVs could be helpful.
- Detection time for a slow growing EV fire often observed in large-scale tests can be longer (double, compared to a fast-growing fire), thus development and testing of alternative early detection methods is recommended.
- A larger gap between two cars implies the flame spread might take longer allowing more time for the crew to muster and gear up before fighting the fire.
- Keeping the ventilation system (jet fans) running onboard the EXPRESS 4, may have a positive effect for smoke control during a fire on the upper vehicle deck (tier 2). On the enclosed vehicle deck (PEARL SEAWAYS) running ventilation during the fire may be dangerous and may lead to a fire spreading after 10 minutes.
- Exposed and uninsulated aluminum structures on EXPRESS 4 can reach critical temperatures from 5 to 18 minutes after the fire starts depending on the fire location and result in a structural failure. Insulation of ferry structures that can be exposed to fire is recommended.
- Time that crew has before the fire spreads to neighboring vehicles may vary between 2 and 6 minutes depending on the ship and location, according to tested scenarios.
- Early sprinkler activation is the key to stopping the fire spread, simple and clear procedures should be developed for this purpose. In cases where drencher zones (PEARL SEAWAYS) are not following the flood control door zones, the decision on the activation should be supported by information on sequence of detection activation, as well as visual inspection.
- In low season, cars should be distributed on all decks to minimize the risk of fire spreading to adjacent cars.
- It is recommended to perform simulations for each specific case, as the results will depend on geometry.

2.3.5 Modelling and Simulation Approach

One of the original purposes of this project was to investigate how fire simulation can give insights into how fire and smoke can spread within a ro-ro vehicle deck, and how current fire protection methods e.g., detection and suppression, perform given different simulated scenarios of an EV fire. The advantages of using simulation tools, is that it allows large, “real” scenarios to be investigated without having to test in an actual ship.

Within the world of Fire Safety Engineering (FSE), there are specifically design computational tools that allow FSEs to run fire scenarios and investigate the potential risks, consequences and life and property safety. The use of these tools is common practice in the design of buildings. However, this type of fire and life safety analysis seems to have found little traction in the maritime industry, even though these tools, typically implementing a form of computational fluid dynamics (CFD) for simulating smoke and fire development, would be applicable to e.g., ships just as much as they are used for buildings.

2.4 References

- [1] M. (RISE) Hjolmahn, F. (RISE) Evergreen, and G. (CMT) Ladage, “LASH FIRE project,” 2022. <https://lashfire.eu/>.

- [2] Institut für Sicherheitstechnik (Rostock-Warnemünde), “Transport of alternatively powered vehicles on ro-ro ferries (ALBERO),” 2022. https://alberoprojekt.de/#xl_xr_page_index-eng.
- [3] C. Lam, D. MacNeil, R. Kroeker, G. Lougheed, and G. Lalime, “Full-scale fire testing of electric and internal combustion engine vehicles,” in *Fires in Vehicles - FIVE 2014*, 2014, pp. 221–230.
- [4] D. Joyeux, “Natural Fires in Closed Car Parks - Car Fire Tests,” 1997.
- [5] A. Lecocq, M. Bertana, B. Truchot, and G. Marlair, “Comparison of the Fire Consequences of an Electric Vehicle and an Internal Combustion Engine Vehicle.,” *Int. Conf. Fires Veh.*, pp. 183–194, 2012.
- [6] O. Willstrand et al., “Toxic Gases from Fire in Electric Vehicles Toxic Gases from Fire in Electric Vehicles,” Borås, 2020.
- [7] L. Vylund, J. Gehandler, P. Karlsson, K. Peraic, C. Huang, and F. Evegren, “Fire-fighting of alternative fuel vehicles in ro-ro spaces,” RISE, 2019.
- [8] L. Vylund and P. Mindykowski, “Methods and equipment for firefighting with alternative fuel vehicles in ro-ro spaces,” Borås, 2019.
- [9] R. T. Long Jr. et al., “Best Practices for Emergency Response to Incidents Involving Electric Vehicles Battery Hazards: A Report on Full-Scale Testing Results,” *J. Chem. Inf. Model.*, vol. 53, no. June, pp. 1009–1010, 2013.
- [10] F. Larsson, P. Andersson, P. Blomqvist, and B. E. Mellander, “Toxic fluoride gas emissions from lithium-ion battery fires,” *Sci. Rep.*, vol. 7, no. 1, pp. 1–13, 2017, doi: 10.1038/s41598-017-09784-z.
- [11] Y. Peng et al., “A comprehensive investigation on the thermal and toxic hazards of large format lithium-ion batteries with LiFePO₄ cathode,” *J. Hazard. Mater.*, vol. 381, no. June 2019, p. 120916, 2020, doi: 10.1016/j.jhazmat.2019.120916.
- [12] P. Sun, R. Bisschop, H. Niu, and X. Huang, *A Review of Battery Fires in Electric Vehicles*, vol. 56, no. 4. Springer US, 2020.
- [13] A. R. Baird, E. J. Archibald, K. C. Marr, and O. A. Ezekoye, “Explosion hazards from lithium-ion battery vent gas,” *J. Power Sources*, vol. 446, pp. 1–24, 2020, doi: 10.1016/j.jpowsour.2019.227257.
- [14] International Maritime Organisation, “SOLAS consolidated edition 2014.” IMO Publishing, 2014, [Online]. Available: www.imo.org.
- [15] IMO, “RESOLUTION MSC.311 AMENDMENTS TO THE INTERNATIONAL CODE FOR FIRE SAFETY SYSTEMS,” vol. 311, no. December 2010.
- [16] P. Gomes, P. Santana, and J. Barata, “A vision-based approach to fire detection,” *International Journal of Advanced Robotic Systems*, vol. 11. 2014, doi: 10.5772/58821.
- [17] C. Li, B. Yang, H. Ding, H. Shi, X. Jiang, and J. Sun, “Real-time video-based smoke detection with high accuracy and efficiency,” *Fire Saf. J.*, vol. 117, no. November 2019, p. 103184, 2020, doi: 10.1016/j.firesaf.2020.103184.
- [18] SICK, “Vehicle Hotspot Detection System,” 2022. <https://www.sick.com/ag/en/system-solutions/profiling-systems/vehicle-hotspot-detection-system/c/g322552>.

- [19] Division for Investigation of Maritime Accidents of the Danish Maritime Authority/ Danish Maritime Accident Investigation Board, “PEARL OF SCANDINAVIA Fire,” pp. 1–14, November 2010.
- [20] International Maritime Organisation, “MARPOL Consolidated edition 2011: Articles, protocols, annexes and unified interpretations of the International Convention for the Prevention of Pollution from Ships, 1973, as modified by the 1978 and 1997 protocols.” 2011.
- [21] C. Petit Boulanger et al., “a Partnership Between Renault and French First Responders To Ensure Safe Intervention on Crash or Fire-Damaged Electrical Vehicles.,” 24th ESV-Conference, pp. 1–7, 2015, [Online]. Available: <http://www.nhtsa.gov/ESV>.
- [22] NTSB, “Safety Risks to Emergency Responders from Lithium-Ion Battery Fires in Electric Vehicles,” vol. 2018, no. 20. p. 80, 2020, [Online]. Available: <https://www.nts.gov/safety/safety-studies/Documents/SR2001.pdf>.
- [23] T. Jahren, “Interview with Bridgehill.” 2021.
- [24] AVD, “What is Aqueous Vermiculite Dispersion (AVD)?” <https://www.avdfire.com/what-is-aqueous-vermiculite-dispersion/>.
- [25] DAFO Vehicle fire protection AB, “FOR A SAFER ENVIRONMENT OF ELECTRIC AND HYBRID VEHICLES,” 2021. https://www.dafo-vehicle.com/media/ufj pz2h0/for-a-safer-environment-of-electric-and-hybrid-vehicles_low-res_bus_v1.pdf.
- [26] D. Stonier, “Interview with AVD’s Business Development Director.” 2021.
- [27] Rosenbauer, “Rosenbauer Introduces the Battery Extinguishing System Technology (BEST),” 2022. <https://www.rosenbaueramerica.com/rosenbauer-battery-extinguishing-system-technology/>.
- [28] MURER-Feuerschutz GmbH, “E-extinguishing lance: operating instruction.” 2022, [Online]. Available: https://www.murer-feuerschutz.de/_pdf/e-loeschlanze/E-Loeschlanze_EN_20211026_WEB.pdf?m=1635259953&.
- [29] Beredskab Øst, “Brandslukningscontainer,” 2019. <https://beros.dk/materielShow.asp?s=79>.
- [30] K. McGrattan, S. Hostikka, R. McDermott, J. Floyd, C. Weinschenk, and K. Overhold, “Sixth Edition Fire Dynamics Simulator User’s Guide (FDS),” NIST Spec. Publ. 1019, vol. Sixth Edit, 2020.
- [31] T. Marton, A. Dederichs, and L. Giuliani, “Modelling of fire in an open car park,” 2015.

3 ELBAS – WP3: Live Fire Testing

DEN DANSKE
MARITIME FOND



The Danish Maritime Fund –
Project number 2021-039

3.1 Introduction

The objective of this series of large-scale experiments was to experimentally evaluate the effectiveness of different firefighting devices against electric vehicle (EV) fires. The experimental set-up was intended to simulate the vehicle deck of a passenger ferry.

EV fires are a growing concern for ferry operators. This concern is due to the unique challenges which these fires present: the danger of reaching the critical thermal runaway (CTR) event within compromised lithium-ion battery (LIB) packs, unease of access to the EVs LIB pack, potential toxic and flammable gases released from the compromised LIB pack, and risk of reignition of the LIB pack hours after extinguishment. Due to these challenges, the performance of traditional extinguishing and firefighting techniques are currently being questioned. Failure to extinguish and control these fire hazards can lead to ignition of adjacent vehicles, compounding the fire risk, or heat exposure compromising the structural members of the ship.

Additionally, EV fire behavior is exceedingly difficult to predict. The growth of an EV fire is dependent on a large variety of parameters ranging from the chemistry of the LIB cells within the pack to the ship's geometry. This uncertainty of fire growth of an EV fire is a key parameter impacting the estimated time for the fire to consume more than a single vehicle. This timeframe is an important factor for the firefighters on board and it could be a useful tool for determining the pre-deployment effectiveness of their firefighting capabilities and the available resources.

As part of the ELBAS project, a core objective was to investigate and evaluate a realistic large-scale test set-up to evaluate the effectiveness of different firefighting devices against electric vehicle (EV) fires. Several firefighting devices and technologies have been developed and tested within this project to extinguish and/or contain the fire to the vehicle of origin. Detailed descriptions of these tests are found in section 3.4. Most of these devices focus on the containment of the fire which is intended to both prevent fire spreading to neighboring vehicles/fuels and provide additional time for fire response options.

Often, the vehicle decks inside ferries are compact and the vehicles are usually stowed near each other. Furthermore, the overhead clearance on these decks can be as low as just above 2 m. Therefore, the use of large devices, navigation, and maneuvering is an additional challenge for this unique environment. Therefore, the usability of these different firefighting techniques within a confined space must also be considered when comparing or evaluating different options.

Considering the above challenges, a series of large-scale experiments were performed where an EV was ignited by means of overcharging the LIB pack. The different firefighting devices and technologies were then put to test against an EV fire. The following sections present the reader with a description of the experimental set-up, the methodology, brief background information on each device, and concluding with the analysis and the discussion on the performance of each device.

3.2 Experimental Set-up

The experimental set-up was designed to represent the conditions and challenges when fighting a fire on a vehicle deck in a ferry at sea. To simulate the enclosed and compact nature of the vehicle deck, the experiments were conducted inside a similar geometry with vehicles stowed tightly close to each other.

3.2.1 Structure

The main structure of the experimental set-up was made by combining two 40 ft ISO shipping containers inside which the vehicles were placed and overcharged until failure. Figure 3.1 below shows the main structure while it is empty for clarity. The gap in the center of the ceiling (Figure 3.1a) was reinforced and sealed with steel plate prior to conducting the experiments (Figure 3.1b). A schematic shown below in Figure 3.2 provides the dimensions of the test set-up including the frame built with the shipping containers.



Figure 3.1: Experimental set-up (a) without the center ceiling and (b) with the center ceiling

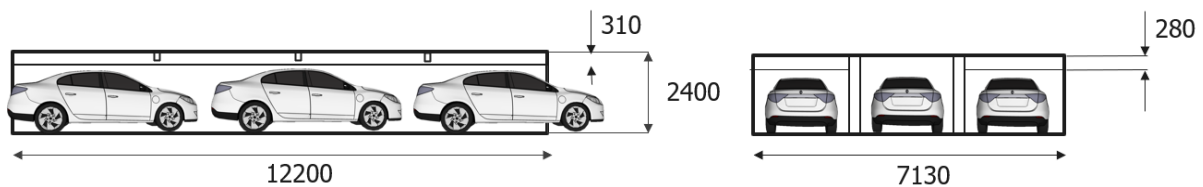

Figure 3.2: Dimensions of the experimental set-up (dimensions in millimeters)

The length and the height of the set-up corresponds to the length and height of a 40 ft ISO container. The length is 12.2 m, the width is 7.13 m, and the height of the set-up is 2.4 m. The ceiling of the structure was insulated with SeaRox SL 620 and Saint-Gobain Isover Ultimate is used in the center directly over the EV first ignited. The side walls were kept uninsulated during all the tests. The floor of the experimental set-up was covered with steel plates with dimensions of 2 m × 3 m and a thickness of 14mm.

3.2.2 Vehicle Arrangement

The tightly stowed vehicles pose challenges for the ship's crew for general maneuvering through the vehicle decks and especially for firefighters deploying tools maneuvering to the fire event. Furthermore, the proximity of neighboring vehicles increases the probability of fire spread.



Figure 3.3: Cramped space inside the experimental set-up

A firefighter wearing the complete fireman’s outfit including equipment will be hindered when moving around such a tightly packed space. Further, the use of firefighting equipment will be difficult and should be designed for use in these conditions. Figure 3.3, captured during the experiments, shows the limited space available for the firefighters to work on a typical tightly loaded vehicle deck.

As an important consideration for the evaluation of firefighting equipment and study of fire spread, the vehicles were placed in the test set-up such that the conditions were like a realistic vehicle deck. The gaps among cars were set to 40 cm and 20 cm (± 5 cm) from door to door and bumper to bumper respectively, as shown in Figure 3.4.

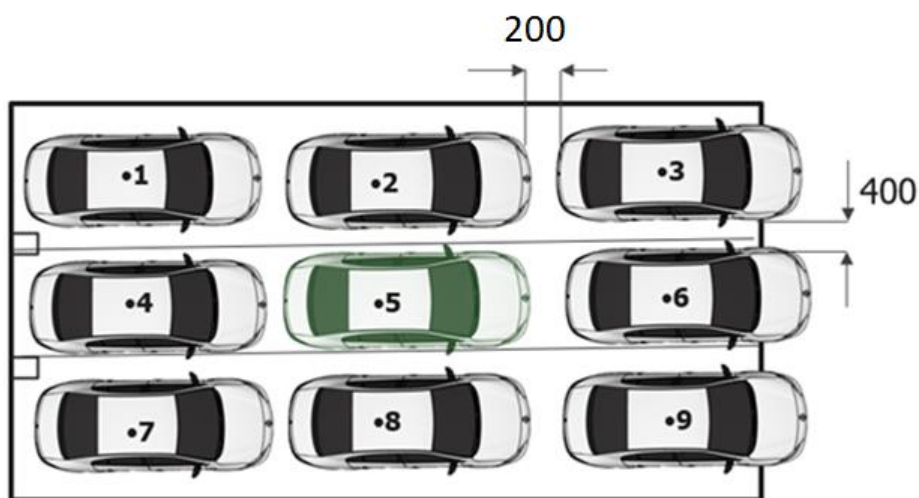

Figure 3.4: General vehicle arrangement [green car (#5) is the EV] (dimensions in millimeters)

The EV was placed in the center of the vehicle ‘matrix’ denoted by car number 5. The surrounding 8 vehicles were conventional internal combustion engine vehicles (ICEVs). It should be noted the ICEVs used were drained of all oils and other fluids and did not contain any fuel in their tanks due to environmental and safety considerations.

The surrounding ICEVs were shuffled around during the experiments depending on the condition of the cars and the EV was replaced after each experiment. Over the course of the tests, the following 3 electric car models were tested: Renault Fluence ZE (2012), Tesla Model 3 (2021) and Nissan Leaf (2011). Specifications of the cars are given in Table 3.1.

Table 3.1: Specifications of the selected EVs

EV model	Electrical energy rating (kWh)	Location of the battery	Number of cars tested
Renault Fluence ZE	22	Behind the back seat	7
Tesla Model 3 (2021)	55	Under the back seat	1
Nissan Leaf (2011)	24	Under the passenger compartment	1

3.2.3 Measurement Equipment

3.2.3.1 Temperature Measurement

Temperatures at different locations were recorded using type K thermocouples. The thermocouples were placed inside the surrounding vehicles on the hoods of cars 1, 4 and 7, on the boots of cars 3, 6, 9, and on the doors facing the EV on cars 2 and 8. Four plate thermometers were placed outside cars 2, 4, 6, 8 facing car 5. The plate thermometers on cars 2 and 8 were placed outside the doors facing car 5. On cars 4 and 6, the plate thermometers were placed on the hood and the boot facing the EV respectively. The placement of the measurement devices including the cameras is shown in Figure 3.5.

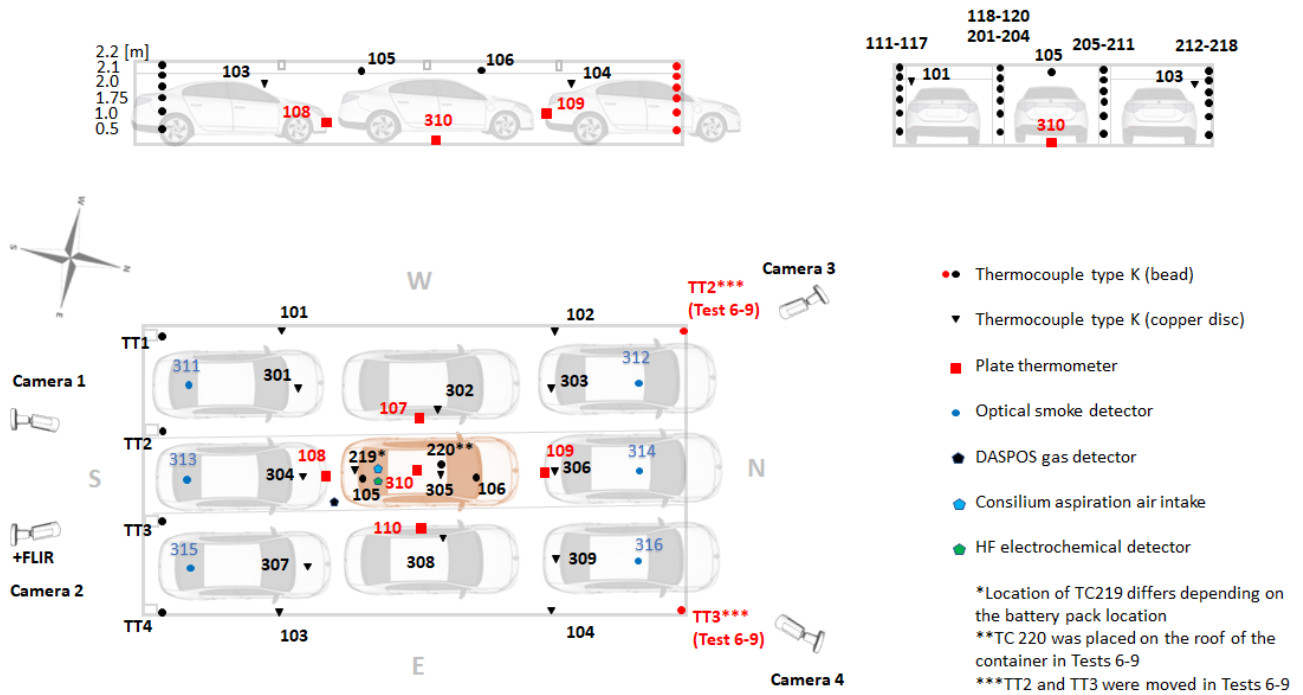

Figure 3.5: Arrangement of the measuring devices and cameras

The thermocouples on the EV were placed inside the passenger cabin in 2 locations: on the roof and another one placed next to the rear-view mirror (TC220) as shown in Figure 3.6. The temperature of the battery compartment was also monitored using a thermocouple attached to it (TC219). The thermocouple was attached on top of the casing of the Li-ion battery pack as shown in Figure 3.7.



Figure 3.6: Placement of TC 220

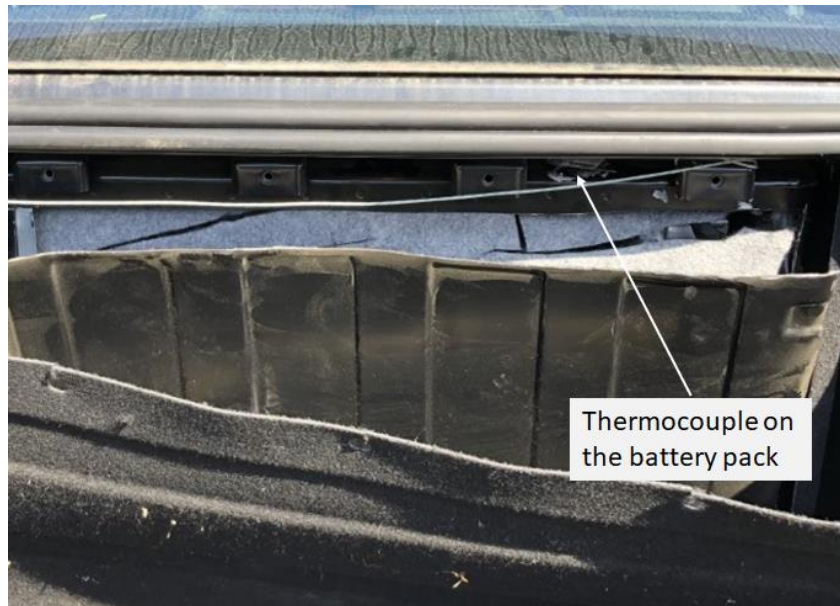

Figure 3.7: Thermocouple placement on the battery pack

The gas temperature above the EV was measured by two thermocouples placed directly above the hood and the boot of the EV at the ceiling level (approx. 2.4 m from the floor). Four thermocouple trees were placed on the openings of the set-up measuring temperatures at heights of 0.5 m, 1 m, 1.5 m, 1.75 m, 2 m, 2.1 m and 2.2 m from floor level as shown in Figure 3.5.

3.2.3.2 Smoke/gas Detection

Six optical smoke detectors were placed at the ceiling level directly above vehicles 1, 3, 4, 6, 7 and 9. Additionally, HF detectors were placed above the EV, near the hood of the EV in some selected experiments. The placements of these detectors are shown in Figure 3.5.

Two types of HF detection were used during the experiments. Aspiration type gas detectors produced by Consilium Safety [1] were placed on the ceiling of the set-up directly above the EV and HF detectors from DASPOS were placed behind the EV in between vehicle 4 and the EV at ground level.

3.3 Methodology

The test methodology is presented in the steps below. The methodology was similar for all the tests performed except for the different devices tested and their operational procedures.

1. The EV was fully charged and placed in the center of the vehicle arrangement.
2. Thermal runaway was initiated via short circuit (electrical abuse).
3. The battery temperatures were monitored to verify whether Thermal Runaway (TR) was achieved.
4. If TR was achieved just by short-circuiting, the conditions were allowed to evolve naturally.
5. If TR was not achieved (according to the battery temperature), ignition was initiated using external means such as placing gasoline burners under the EV.
6. The firefighters waited until the 10 min mark after the first optical smoke detector was triggered. The waiting time of 10 min was chosen based on information provided by the partner ferry companies. Once the alarm was activated indicating a potential fire, the crew would muster and gear up to fight the fire. This procedure takes approximately 10 min.

7. The selected firefighting device was used against the EV fire (10-min after first alarm) and additional external help was provided only when it was deemed necessary based on the conditions inside.
8. The experiment was considered fully completed when the EV fire was fully extinguished. Specifically, when the temperature of the battery dropped below 50 °C.

Table 3.2: List of experimental set-ups and fire scenario details

Experiment ID	EV model	SoC	Extra battery/ energy rating	Devices used	Extinguishing media
1	Renault Fluence ZE	100%	No	Bridgehill fire blanket	Fresh water
2	Renault Fluence ZE	100%	No	E-lance - battery piercing device	Sea water
3	Renault Fluence ZE	100%	No	BEST Rosenbauer - battery piercing device	Fresh water
4	Renault Fluence ZE	130%	Yes/ 0.76kWh*	Jøni EV firefighter – portable water-cooling device	Sea water
5	Renault Fluence ZE	100%	No	DAFO Water curtains	Sea water
6	Tesla Model 3	100%	No	Water mist system	Fresh water
7	Renault Fluence ZE	100%	Yes/ 0.76kWh*	E-lance and water mist system	Fresh water
8	Nissan Leaf	100%	No	Bridgehill fire blanket and water mist system	Fresh water
9	Renault Fluence ZE	100%	Yes/ 0.76kWh*	Jøni EV firefighter and DAFO water curtains	Fresh water

* The extra battery was at an SoC of 120% before the experiments.

When operating each device, depending on the working mechanism of the device, additional steps were taken. These additional steps will be discussed in the following section which provides background information on different firefighting devices used during the tests.

3.4 Tested Devices and Technologies

Different firefighting devices and technologies are available in the current market but each with different approaches. Some devices directly address the battery fire and cool the battery temperature below the TR onset but with less focus on cooling the area surrounding the battery pack. Another way of approaching an EV fire is to ensure that the fire remains always under control without the fire spreading to the surroundings. Containment of the flames is the primary focus of these methods while the direct cooling methods focus on cooling the battery pack. Both methods can be effectively used to fight an EV fire. However, due to the narrow focus on each method, there are disadvantages as well, when depending only on one type of method.

The devices selected for the ELBAS tests were chosen based on the review of currently available systems performed under the second work package, section 2.2.3, of this project.

3.4.1 Car Fire Blanket

3.4.1.1 Background

Fire blankets are an effective solution for ICEV fires. These blankets, made of high temperature resistant materials, are designed to contain the smoke and flames within the covered car. This method of fire protection does not extinguish the vehicle fire but instead contains the fire which can continue potentially until burnout.

The Bridgehill Car Fire Blanket [2], shown in Figure 3.8 is a fire blanket intended for use against EV fires. The general dimensions of the blanket are 6 m × 8 m and weighs approximately 26kg [2]. The standard model single use blanket was used in this experiment.



Figure 3.8: Standard Bridgehill Car Fire Blanket unrolled on the ground ready for use

Using the blanket is relatively straight forward, but two fire fighters are required to pull the blanket from each side and over the car on fire. When using on tightly stowed vehicle deck on a ferry, the two firefighters must go around and over the adjacent vehicles to reach the car on fire (see Figure 3.3). Due to the size of the blanket and the provided handles on the corners, with some initial training the fire fighters testing the blanket demonstrated it is possible and relatively easy to use. This method also gave some additional protection to the firefighters deploying the blanket as they were shielded from the ignited car to some degree by the neighboring cars.



Figure 3.9: Bridgehill Car Fire Blanket being used during experiment 1

The fire blanket's main purpose is to limit the flame spread to adjacent vehicles or to the structural elements and provide enough time for the vessel to reach land and get external landside assistance. The performance of the Car Fire Blanket was tested in experiment 1 and is discussed in section 3.4.1.2. The fire blanket was used as a standalone technology without the assistance of secondary firefighting technologies, such as water mist.

3.4.1.2 Results and Discussion

After the fire blanket has been placed over the ignited car, it limits the oxygen available to the fire from the surrounding environment. This method of fire response would smother most fires, but the combustion process of EV LIB packs is somewhat different. Once the LIB pack has passed the point of TR and becomes involved in the fire, a byproduct of the decomposition of the electrodes within the LIB cells is oxygen. This stage of self-production of oxygen tends to accelerate fire development. Placing the fire blanket over the involved EV will cause heat feedback cycle on the compromised LIB pack which in turn will likely result in complete burnout of the vehicle. The temperature of the battery compartment recorded during the test is shown in Figure 3.10. It should be noted that the battery had to be ignited using EXXOL D60 after no ignition was achieved via short circuiting the fully charged battery pack.

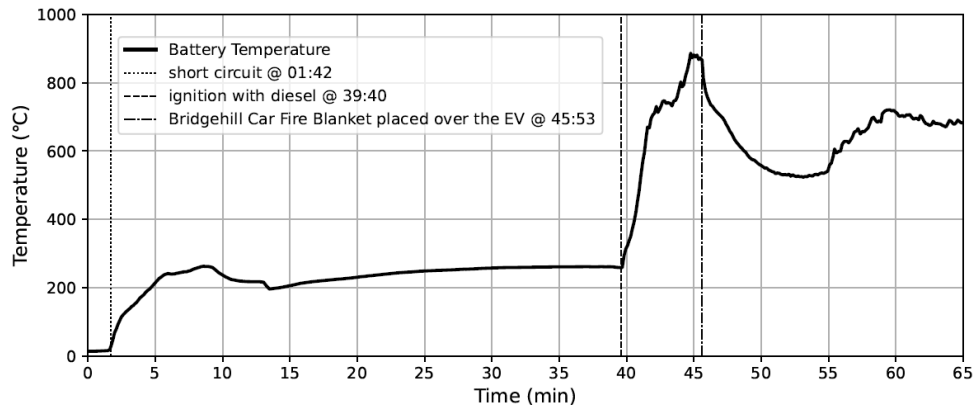

Figure 3.10: Battery compartment temperature during experiment 1

As seen in Figure 3.10, the temperature of the battery compartment was 886 °C just before the blanket was placed over the car. A sudden drop of temperature was observed after the car on fire was fully covered by the blanket. The minimum temperature was recorded at 523 °C afterwards but, the battery temperature started to slowly rise before it reached a steady temperature of around 680 °C. After the blanket was placed, the temperatures in the battery compartment never dropped below 500 °C during the logged time. Nevertheless, the initial sudden drop of battery temperature could be due to the limited oxygen during that phase but, the battery was already in the TR range which caused the temperatures to rise.

Containment of flames is a key performance indicator of a fire blanket, but this requires that the blanket is used before flames have spread to adjacent environment. During the experiments, it was observed that flames and smoke could penetrate through the blanket or go under the edges of the blanket as shown in Figure 3.11.

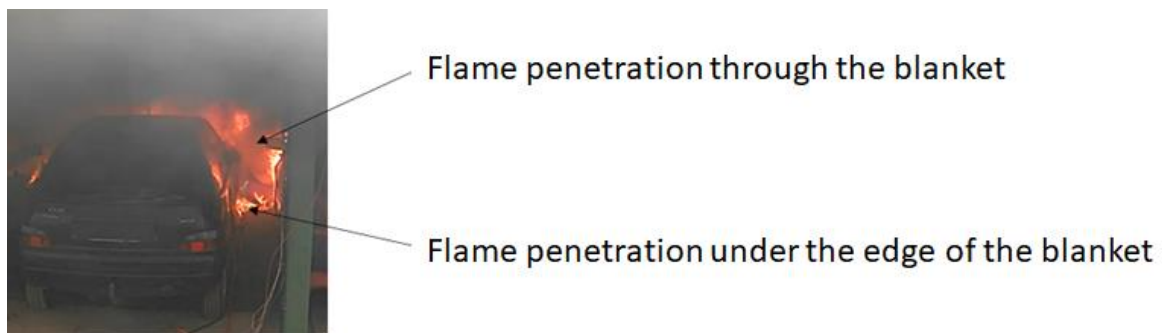

Figure 3.11: Flame penetration through the fire blanket

Flames were observed in the vicinity of car 7 even before the blanket was deployed. This highlights the importance of response time using a similar blanket where the main advantage is containment of the fire to a single vehicle. However, the temperature readings from TC 105 and TC 106 show that the conditions around the EV changed as soon as the EV was covered by the blanket and continued to be that way. The temperatures around the EV (at the ceiling level) dropped from around 600 °C to below 100 °C soon after the blanket was used. This indicates that the blanket was able to contain the EV fire and it is highly unlikely that another vehicle would catch fire in temperatures below 100 °C.

3.4.2 Extinguishing Lance

3.4.2.1 Background

This device, in contrast to a fire blanket, is focused on providing direct cooling to the battery. This type of extinguishment method can be considered aggressive since the device has to be used directly on the top of the battery itself regardless of the surrounding conditions. The device, as shown in Figure 3.12, weighs approximately 7kg to 8kg depending on whether the extension tube is attached or not [3].

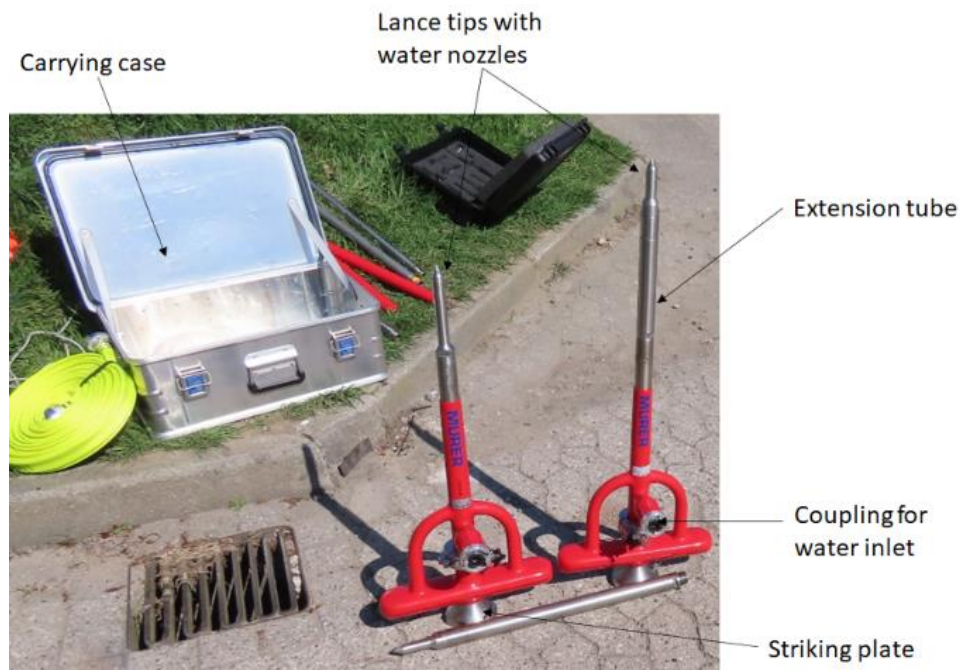

Figure 3.12: E - Extinguishing Lance by Murer-Feuerschutz GmbH with the extension tube and carry case

The working principle of this device is, once the LIB pack location is determined, the lance tip is placed above the LIB pack and then hammered into the LIB pack using the striking plate. The lance will need to be held by one firefighter while another strikes on the striking plate with a sledgehammer, refer to Figure 3.13. Once the pack is penetrated, the water supply can be activated which provides direct cooling on the battery modules itself. This method of cooling is intended to apply a cooling spray of water droplets directly onto the compromised LIB and absorb heat energy. This increases the efficiency of the used water and significantly reduces the amount of water required to bring the battery temperature down to a desired level.



Figure 3.13: Holding the E-lance in place prior to striking

3.4.2.2 Results and Discussion

Since the lance must reach the battery pack, prior knowledge of the location of the battery in the car is required. It is not likely that this information will be easily available to the firefighting crew on board. During the experiments, the trained professional firefighters knew beforehand where to strike and where the battery pack was located. Furthermore, Renault Fluence ZE model was designed in favor of providing easy access to the battery modules through the opened boot. Depending on the design of the vehicle, it can be a more tedious task to reach the battery pack with this device. Once the lance had pierced through the battery, it stayed in place even with the water supply on. Figure 3.14 shows the lance standing in place still attached to the battery pack after the experiment was finished.



Figure 3.14: E - Lance on the battery after the experiment

Using this device in a confined space with a low ceiling height slightly hampers the swing of the sledgehammer. This leads to an increased number of strikes before the lance penetrates the battery pack. This was observed during the experiments when the sledgehammer contacted parts of the ceiling during full swings. During the E-Lance testing day, flaming combustion was not achieved on the battery pack and therefore, the conditions inside the structure were not as severe as in a fully engulfed flaming EV fire. The temperature variation with time before the device was used and after is shown in Figure 3.15.

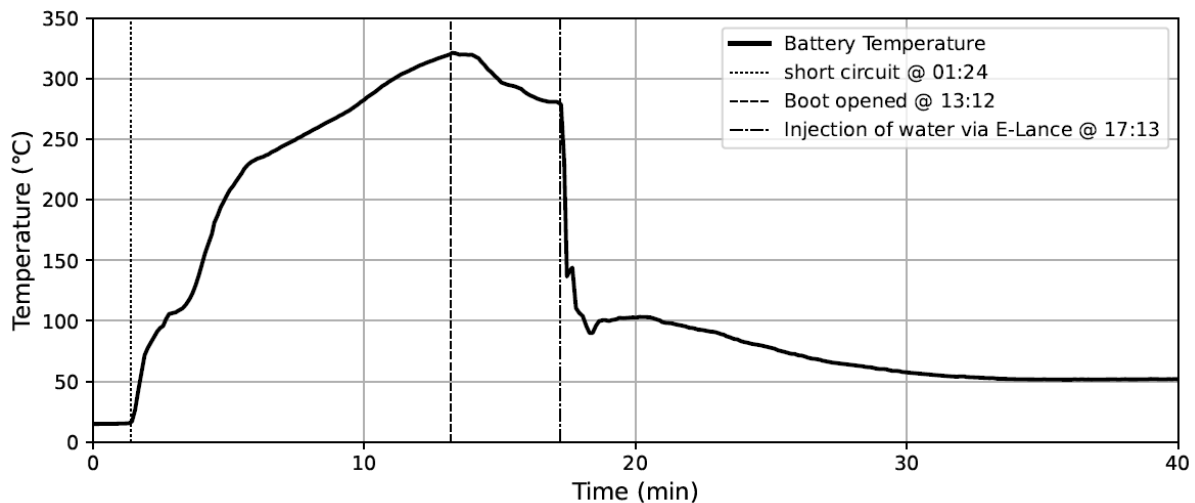

Figure 3.15: Battery compartment temperature during experiment 2

An increase in the temperature to 321 °C after the 13 min. mark can be observed initially after the short circuit onset. A slight but noticeable drop in temperature was observed when the boot was opened by the firefighters to deploy the lance. However, the temperature started to stabilize at around 280 °C just before the water supply was turned on. After this point a rapid drop in temperature was observed and this trend continued around the 32 min. mark where the battery compartment temperature remains constant around 50 °C.

An important factor that can be observed from Figure 3.15 is the time taken from reaching the battery pack and to turning on the water supply. This time could be considered approximately as the time gap between the dashed line and the dash-dotted lines. During the experiments, it took 4 min from reaching the vehicle until water had been applied on the battery. It should be noted that prior knowledge of the battery available to the firefighters had a direct effect on this time gap.

Direct cooling of the battery is advantageous and extremely efficient when controlling the battery fire. The battery pack was cooled down with a considerably lower water consumption compared to other water based extinguishing systems used in this series of experiments. However, this device is not capable of putting out the flames inside the passenger cabin. The device is most appropriate when only the battery fire is the concern. It is therefore required that the flames outside the battery have been put out prior to using this device. This makes it much easier for the firefighters to attack the battery without the effects from external flames and smoke. The intended use of the device is primarily to cool down the battery after the fire has been extinguished and during the experiment it could successfully bring the LIB temperature below TR onset temperature. It is worth noting that this device was used further after some of the other experimental tests as a precautionary method to ensure the battery TR reactions had stopped completely.

3.4.3 Battery Extinguishing System

3.4.3.1 Background

A similar device to the E-lance, focusing on direct cooling of the battery, has been developed by the company Rosenbauer. The device can be considered as an automated battery piercing device which can be controlled further away from the battery fire after the piercing device has been placed in the desired location. Using

the device requires two main steps: placing the piercing device and activating the piercing mechanism afterwards. Operation of the device requires two firefighters: one to place the piercing device and another one at the control unit to activate the device as shown in Figure 3.16.



Figure 3.16: BEST by Rosenbauer [4]

The piercing unit weighs approximately 26 kg which must be pushed under the vehicle directly under the battery pack before it is activated. The water flow rate through the device is 30 l/min (8 gallons/min) at a pressure of 7 bar (100 psi). The ride height of the vehicle and the location of the battery pack must be compatible with this device for proper usage. Otherwise, additional steps such as lifting the vehicle using a jack or deflating the tires to bring the vehicle down should be taken. Due to these uncertainties, the flexibility of the device is of a major concern. Despite these drawbacks, one major advantage of the device is the fact that it can minimize the time spent near the battery fire. Once the piercing device has been placed, the firefighter can retreat away from the fire and the expected buildup of toxic gases and heat. Furthermore, the direct application of water on the battery will efficiently cool the battery down to safe temperatures with low water consumption.

3.4.3.2 Results and Discussion

The reach of the BEST piercing lance was insufficient to fully pierce the battery pack of Renault Fluence ZE. Therefore, the tires of the EV were deflated which allowed the battery pack to be pierced with the BEST. The BEST was also placed prior to the EV being ignited but only activated 10 min after the first smoke detector was triggered.

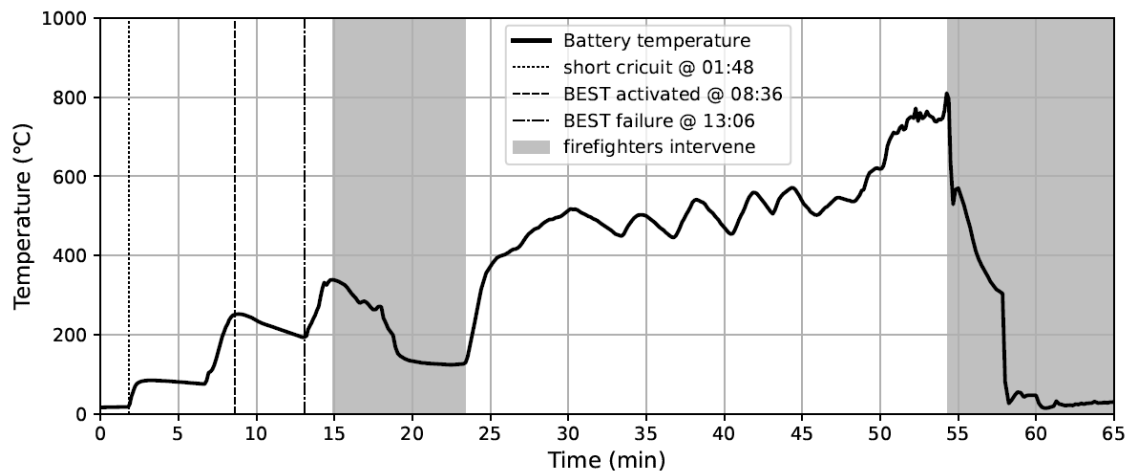

Figure 3.17: Battery compartment temperature during experiment 3

A noticeable drop in battery temperature was observed after BEST was activated (battery temperature at 251 °C) and water was applied on the battery. However, after 4.5-min, the battery temperature started to rise even while the device was in operation. The battery temperature eventually rose beyond what it was when the device was activated. At this point, the device was assumed to fail in cooling down the battery and the firefighters intervened and attacked the fire. Therefore, even after activation of the BEST the compromised LIB pack continued to produce heat and propagate TR within the LIB. Finally, after 54 min the fire was completely extinguished, and the battery temperature was brought below the TR onset temperature.

The failure of the device could be related to the battery compartment being opened during short circuiting process. This configuration did not allow the water to be kept within the battery compartment. Upon, further investigation after the experiments, it was observed that the device successfully pierced through the battery compartment [Figure 3.18a] but, due to the opened compartment [Figure 3.18b], the attempt was unsuccessful at completely stopping TR. The device relies on the injected water remaining in the battery pack absorbing heat from the battery, failing to do so leads to propagation of TR within the LIB pack.



Figure 3.18: Post fire LIB pack of (a) pierced battery compartment and (b) the opened battery compartment after the experiment

The battery extinguishing system technology (BEST) by Rosenbauer is suitable for battery packs which are located on the underside of the vehicle. Locating the exact battery pack which is on fire is vital to the

effectiveness of the device. In vehicles where the batteries are split up and spread around the structure of the vehicle could be an additional challenge during the extinguishing process. In situations where more than a single battery pack has reached TR conditions, the device is not capable of providing effective cooling. If the BEST is effectively used on the battery pack on fire with due time, the device can cool the battery pack down with a lower water consumption like the E - Lance.

3.4.4 Portable Mist Curtain with Undercarriage Cooling

3.4.4.1 Background

In contrast to the previous two firefighting devices presented, EV Firefighter by the company Jøni Aabybro ApS does not focus on cooling the battery down. Instead, the purpose of the device is to cool down the surroundings via water sprays, containing the fire to the original vehicle. The device can be considered as an array of water mist nozzles mounted on rails which can be pushed on the sides and under the EV as shown in Figure 3.19.

The rails come with wheels mounted on the bottom for easier handling. Additionally, the device must be first connected to the water supply before placing it. Afterwards, two firefighters should place rails on each side of the burning vehicle and the smaller array under the burning EV. The intention is to create a water barrier around the EV through which the flames cannot penetrate and spread. Such a device, if used as intended, might keep the fire from growing and spreading until the ship reaches the shore. However, the device must be placed prior to the flames spreading to the surrounding environment.



Figure 3.19: EV firefighter by Jøni Aabybro during experiment 4

3.4.4.2 Results and Discussion

During experiment 4, the EV battery was overcharged to 130% and the boot of the EV was left opened prior to short circuit to induce a stronger TR reaction. Shortly after a short circuit approximately at the 2 min mark,

the battery compartment caught fire and the fire grew rapidly. Flame spread around the burning vehicle and to adjacent vehicles was observed within 5min after ignition before the devices were pushed inside.

Figure 3.20a shows the evolution of the battery temperature. Figure 3.20b shows the temperatures recorded on the external surface of the doors facing the EV. Specifically, the doors on car 2 and car 8.

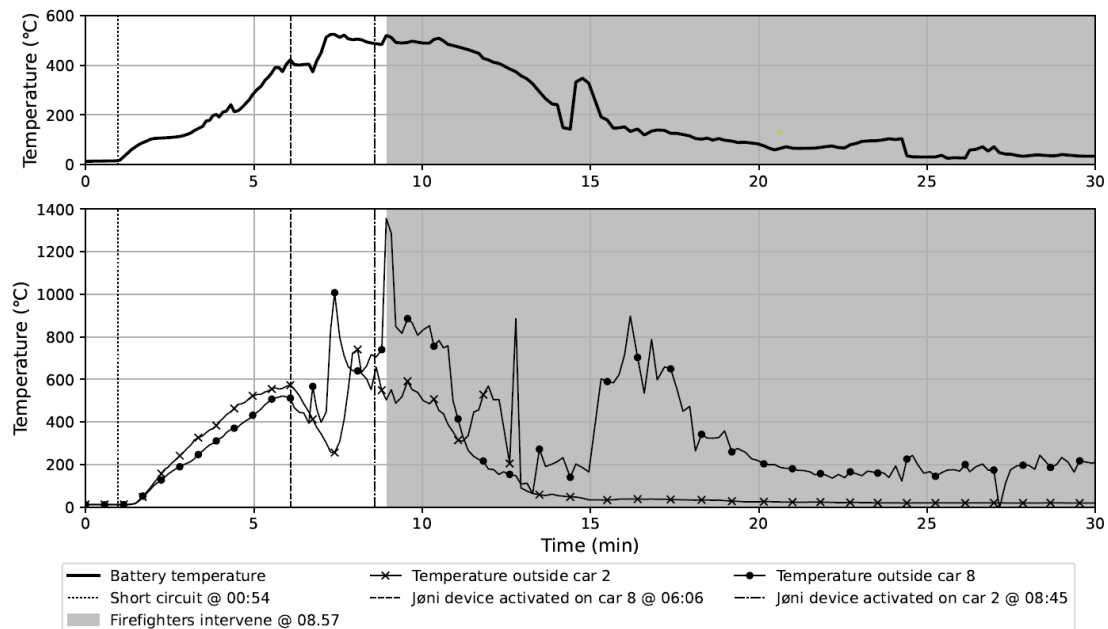

Figure 3.20: Temperature reading during experiment 4. (a) Battery compartment temperature and (b) temperatures of the exposed sides of adjacent cars

Due to the nature of this device, it is highly unlikely that this device will cool the battery down on its own. This is due to the battery being located inside the structure of the vehicle in an enclosed space. This does not allow the water droplets to reach the battery pack, which is evident from the battery temperature evolution shown in Figure 3.20a. The battery temperature was not affected after the EV firefighter was activated. A substantial decrease in the battery compartment temperature can be observed only after firefighters decided to attack the fire directly.

Temperatures higher than 500 °C were already reached when the EV firefighter rails were pushed in on the sides of the car. Visual observations confirmed that flames had spread over to the cars on all sides by this time. The EV firefighter uses a technique focused on minimizing flame spread, it was at a disadvantage due to this reason. Furthermore, the rails only had water mist nozzles facing towards the EV but not away from the EV. Therefore, any flames on the blind side of the nozzles were not affected by the water spray. Even though within 3 min the EV was surrounded by the water mist arrays, the fire kept growing fast. Due to that it was decided to send in firefighters to attack the fire using the conventional firefighting hoses for safety reasons.

The usability of the device in a tight space could be challenging due to its large size. Maneuvering the rails through a vehicle deck filled with vehicles could take a longer time. However, choosing a favorable entrance to the vehicle deck could assist the firefighters to reach the fire in quick time.

3.4.4.3 Second Test with Extinguishing Lance

This device was put to test for a second time, this time in combination with the E - Extinguishing Lance by MURER-Freuerschutz GmbH. It was observed that cooling was necessary on both sides of the rails to fully cool down the surroundings in the vicinity of the EV. The nozzle layout on the rails was modified with nozzles facing both into and away from the EV.

EV Firefighter rails were used before the fire had spread to the adjacent vehicles. Furthermore, the array of water mist nozzles was doubled this time, with additional nozzles facing away from the EV. The effect of timely activating device and the additional nozzles were evident and flame spread was kept under control during this run. This highlights the importance of reaction time of the fire crew when depending on such a device. However, due to the unpredictable nature of EV fires, even the quickest credible reaction could be ineffective in some instances as observed during experiment 4.

3.4.5 Portable Water Mist Curtains

3.4.5.1 Background

An underdevelopment side water curtains made by Dafo Comtec AB were tested against an EV fire during experiment 5. The device has a similar principle to the EV Firefighter developed by Jøni Aabybro ApS but, the compact and linear design increases ease of handling this device in an enclosure with limited space, however this also comes with a reduced water output. The device is a single rail with an array of water mist nozzles attached to the rail. The device should be pushed using the provided steel bar on each side of the EV while being connected to the water supply as shown on Figure 3.21a. For each side, a firefighter is required to push the device in. The device lies on the ground once placed near the EV with the water mist nozzles facing the ceiling as shown in Figure 3.21b.



Figure 3.21: Albero/dafo water curtains (a) during firefighting operations and (b) before the experiment set-up

Once the device has been placed, the water supply can be activated to release the water spray from the nozzles. This water curtain is to act as a barrier for flame spread and keeps the fire contained within the originally ignited vehicle. The device is not capable of providing cooling directly on the battery pack due to its design.

3.4.5.2 Results and Discussion

During experiment 5, even though the battery pack was fully charged and short circuited, TR was not achieved. However, the EV was ignited using a diesel pool fire placed under the EV. Even during the fire, battery compartment temperatures suggest that TRA was not achieved. The battery temperatures and the

temperature recorded inside the passenger cabin are shown in Figure 3.22a. The temperatures of the sides of the adjacent cars are shown in Figure 3.22b.

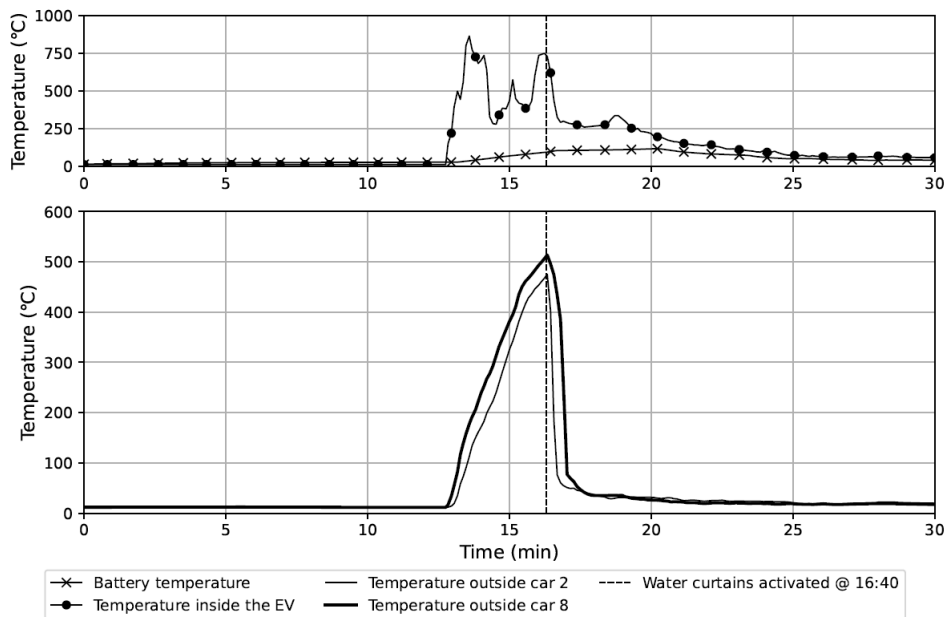

Figure 3.22: Recorded temperatures during experiment 5 of (a) the EV passenger cabin and (b) the exposed sides of adjacent cars

In review of the temperatures recorded around the water curtains on each side, a steep drop was observed as soon as the water supply was activated. Within a few minutes, the devices were able to reduce the temperature of the surroundings and inside the EV to a large extent. However, the effect on the temperature inside the EV was due to the windows being opened. In a real-life scenario, this cannot be assumed to be the case unless the firefighters decide to break the windows. Had the battery pack reached TR, the effect from this device can be assumed as minimal or negligible on the battery temperature.

Quick reaction is the key to the efficiency of this device, as it was for EV firefighter by Jøni Aabybro ApS. During experiment 5, flame spread was observed on both sides (on car 2 and car 8) just before the devices were placed as shown in Figure 3.23. However, due to the upward spray from the rails, cooling water was able to reach both sides of the EV which was not the case for the EV Firefighter before additional nozzles were added in on the rails in the modified version. In that regard, the simple design of these side water curtains provides cooling to both sides of the rails in an efficient manner.

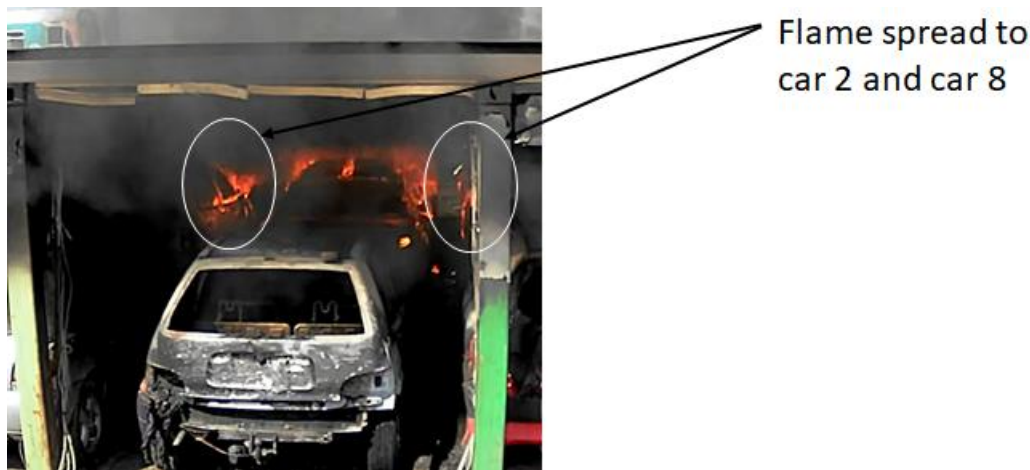

Figure 3.23: Flame spread to car 2 and car 8 during experiment 5

The water consumption of this device was lower compared to the EV firefighter by Jøni Aabybro ApS mostly due to the differences in the nozzle layouts of the two devices. Still, the least water consumption can be expected from the device which provides direct cooling on the battery pack.

3.4.6 Low-Pressure Water Mist System

3.4.6.1 Background

Water mist systems usually require high operating pressures to be able to generate a fine enough water droplet distribution within the spray. Sprinklers on the other hand generate a spray with larger droplets with low operating pressure. Due to the finer droplets providing better heat absorption characteristics, water mists are often more efficient compared to sprinklers in terms of water consumption. However, water mist systems are equipped with components with a high-pressure rating making the whole system more expensive compared to a sprinkler system. Low-pressure water mist systems attempt to eliminate the downside of both conventional water mist and sprinklers and provide a water spray with better heat transfer characteristics with cost efficient components. In Figure 3.24, the nozzle head is shown alongside its dimensions.

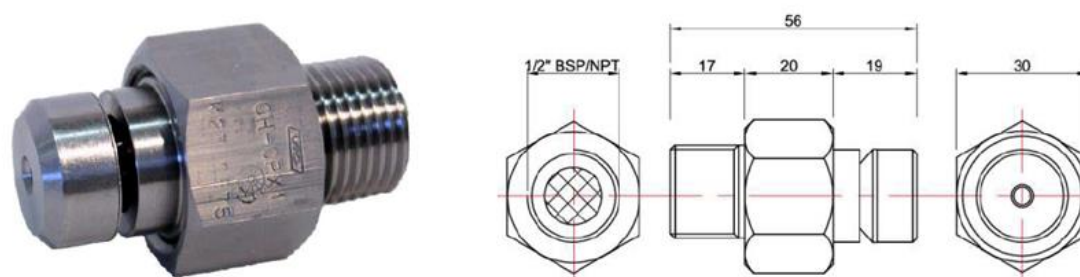

Figure 3.24: VID Fire-Kill low pressure water mist nozzle (left) and the dimensions (right)

The operating pressure range for the system is from 6 bar to 16 bar which is lower than the pressure requirement for a conventional water mist system. The coverage by the spray cone from a single nozzle varies from 12.25 m² (3.5 m² × 3.5 m²) to 16 m² (4 m² × 4 m²) and can be installed on ceiling heights up to 2.5 m and

5m [5]. As per the product data sheet [5], 90% of the water droplets from the nozzle will have diameters less than 300 μm . The housing of the nozzle is made of brass (ANSI 304) with a Ni-Sn coating.

3.4.6.2 *Results and Discussion*

The low-pressure water mist nozzles were evenly distributed in the experimental set-up with six nozzles fixed on the ceiling directly above car 1, 2, 3, 7, 8 and 9. The water mist system was activated 7.5 min after the first detector signal was received. The EV was ignited using a diesel pool fire placed under the battery pack after ignition was not achieved via short circuit. The temperature evolution of the battery compartment [Figure 3.25a], the smoke layer temperature directly above the EV [Figure 3.25b], and the temperatures of the exposed sides of the surrounding vehicles (car 2, 4, 6 and 8) [Figure 3.25c] are shown below.

The EV chosen for experiment 6 was different from the previous experiments. A Tesla Model 3 (2021) with a new battery was used for the experiments. The car was not in good condition, a set of passenger seats was placed inside, and the roof was covered with a steel plate to avoid water droplets reaching the passenger compartment from above.

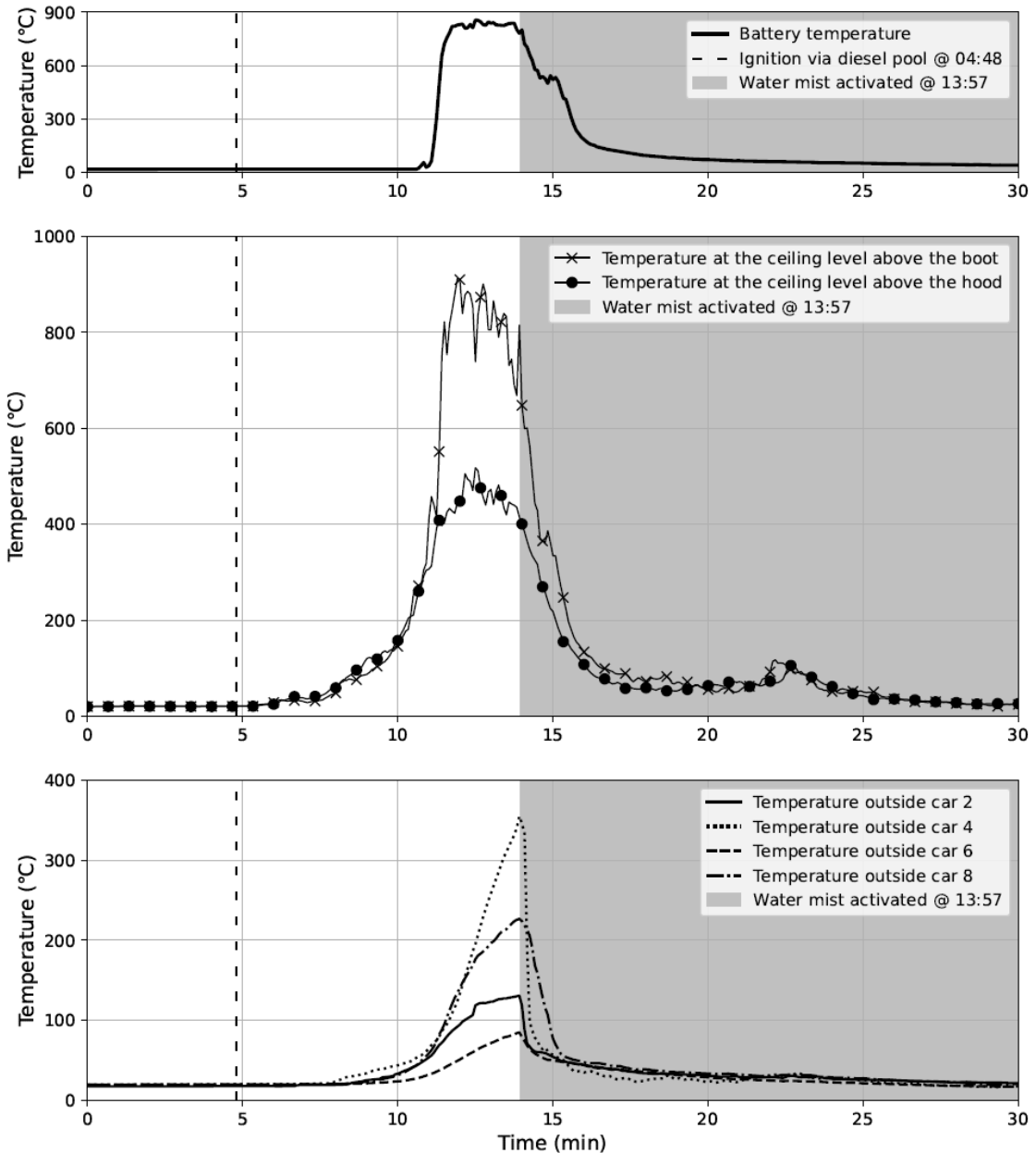
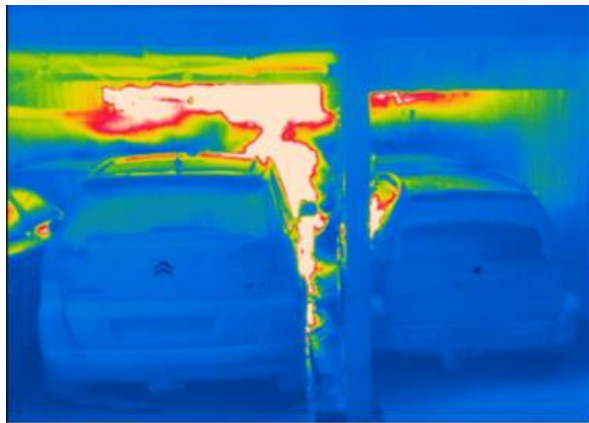
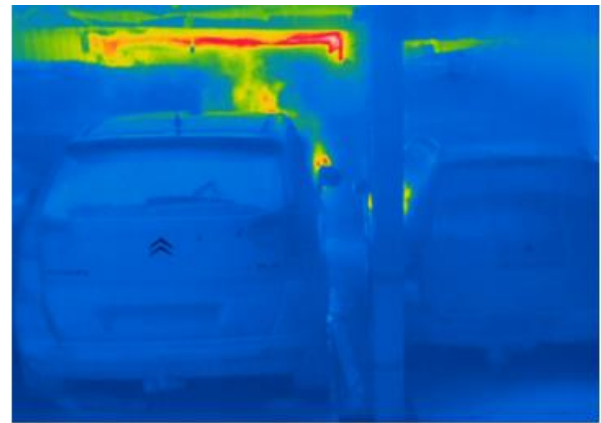

Figure 3.25: Temperature of the battery compartment (a), smoke layer temperatures above the EV (b) and temperatures of the exposed sides of the surrounding cars (c)

Unlike all previously mentioned techniques, a water mist system will not necessarily target the battery or the EV, but it will produce a spray once activated from its fixed position. If the nozzles are installed with good coverage, the effects of water mist can be felt on the burning car itself and the surroundings including nearby structural elements. As soon as the water mist system was activated, a drop in temperature on the battery, smoke layer above the EV and the surrounding cars were observed. The temperature drop in the battery was most likely due to the bad condition of the EV allowing droplets to reach the battery pack which would otherwise be better shielded from the water mist. The cooling effect on the surroundings can be clearly seen on the snapshots taken from the thermal imaging camera as shown in Figure 3.26.



a) 3s after activation



b) 30s after activation



c) 90s after activation



d) 150s after activation

Figure 3.26: Thermal images of the surrounding after sprinkler activation; a) 2 sec after activation, b) 30 sec after activation, c) 90 sec after activation, d) 150 sec after activation

Figure 3.26 shows how the conditions in the vicinity of the EV fire had evolved during experiment 6. Initially hotspots were observed emerging from the EV and on the window railings on the adjacent cars on the left and right to the EV suggesting flame spread at that point. However, within 90 sec all the hotspots disappeared and within 150 sec the conditions inside the set-up (in terms of temperature) had changed to an environment with mild temperatures on the cars and the surroundings. This shows the larger coverage of water mists systems compared to the previously discussed firefighting systems. However, the battery temperature after 150 sec of water mist system activation is around 140 °C and further decreases with time.

The water mist system proved to be capable of handling the surrounding environment and reducing temperature at a rapid speed in a large area in less than 2 min after activation. However, depending on the design of the car (location of the battery), a similar effect on the battery cooling might not be achieved in all the cases. Nevertheless, if the water droplets reach the battery pack and with proper activation and layout, water mist systems appear to be capable of dealing with EV fires (i.e., containing the fire) successfully.

3.5 Additional Findings

3.5.1 Fire Characteristics

Over the series of experiments, a similar methodology was used to induce thermal runaway (TR) and the conditions were then allowed to develop without any intervention. However, the time taken to reach TR and the overall development of the fire was different for each experiment. During experiment 2, flaming combustion was not achieved whereas with the same methodology, much larger fires were induced in the other experiments. The unpredictable nature of EV fires was evident during the experiments.

Flame spread to adjacent vehicles is dependent on the fire development. Due to the unpredictable nature of an EV fire, the time taken for the flames to consume adjacent vehicles is also unpredictable. However, it was observed that the rubber railing of the windows was the first ignited item on an adjacent car when the car is next to the EV as shown in Figure 3.23.

3.5.2 Gas Measurements and Detection

The HF measurements recorded from the two detection systems showed that location of the detections system affects the alarm time. The firefighters also carried wearable gas detectors [6] with them which could also trigger an alarm when the concentrations of a gas species are higher than the threshold. However, during the experiments these devices did not trigger any alarm on the danger from the gas species even though both detection systems installed indicated high levels of HF in the vicinity of the EV.

The selective gas detectors from Consilium [1] could detect hydrocarbons, CO, and HF at the same time. The measured concentrations of HF, hydrocarbons (HC) and CO are shown in Figure 3.27.

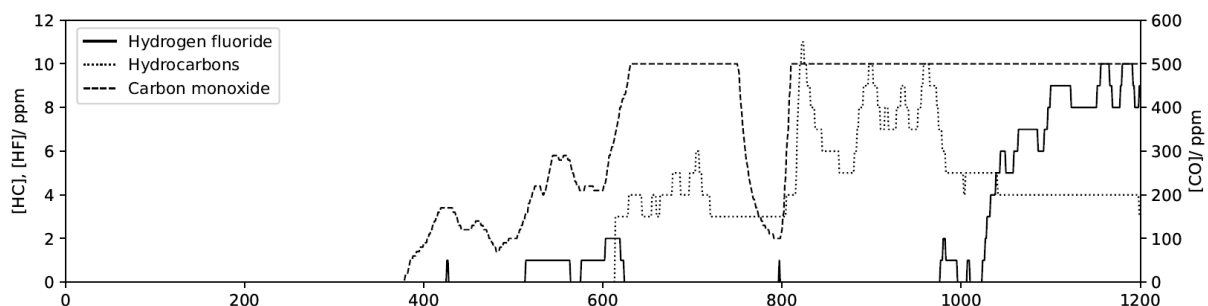

Figure 3.27: Live measurements of HC, HF and CO concentrations from experiment 6

During experiment 6, short circuiting did not lead to ignition of the battery pack. Therefore, a gasoline burner was placed under the battery pack to initiate ignition. When comparing the detected concentrations of each species, CO and unburnt HC was detected by the detectors 15 min – 10 min earlier than HF. The use of a pool fire could be a probable reason for this gap between the detection times among the species. HF is only emitted when the battery pack has reached TR whereas, unburnt HC and CO could be emitted via different burning items such as the passenger car seats and other plastic material present. However, the rapid increase of detected HF concentrations clearly suggests that EV fires could be detected via HF detection. It is not 100% clear from these experiments which method of detection could be the better option due to the use of the gasoline pool fire beneath the battery pack. It should be noted that the concentrations measured by these detectors are capped at 10 ppm (for HF and HC) and 500 ppm (for CO), therefore, the actual concentrations could be higher and beyond the limits of the device.

The earliest detection times of the smoke detectors from experiments 1, 2, and 3 are given below in Table 3.3. The arrangement of the optical smoke detectors is shown in Figure 3.5.

Table 3.3: The earliest detection times recorded during the experiments

Experiment ID	Detection time (s)*	Detector ID [Figure 3.5]
1	111	SD 311
2	107	SD 313
3	119	SD 313

*Time measured after initiating short circuit

The detection times are less than 2 min for all three experiments which shows that even with conventional optical smoke detection, low detection times could be achieved. However, due to the extra time requirements related with firefighters gearing up, the conditions could escalate towards extremes by the time the firefighters are ready to fight the fire.

3.5.3 Weather Effects

Wind effects were visible in the temperatures measured from the thermocouple trees. The smoke movement within the set-up was affected by the presence of wind. Recorded temperature from the thermocouple trees confirmed these effects. Higher temperatures were recorded on the downwind side of the set-up implying the hot smoke had been pushed in that direction.

The location of the first activated detector reflects the phenomenon described above and it was evident that the earlier detection times were recorded on the downwind side on the set-up. Similar observations were made during the CFD simulations detailed in section 0 (WP2: Technological Aspects – Fire Scenarios and Technologies).

3.5.4 Structural Response

Plate thermocouples attached to the structure on the inside surface showed varied temperatures on each experiment. The temperatures on the structure reached as high as 500°C during experiment 4. During the same experiment, the ceiling of the structure began to sag even with the protection of the insulation provided against the flames.

3.5.5 Use of Sea Water as Extinguishing Medium Sea vs Fresh Water

Sea water is the primary medium used in fixed firefighting systems onboard ships, given its plentiful availability and unlimited supply.

As noted earlier, toxic and flammable gases can be generated when using sea water as a firefighting medium. Electrolysis of salt water, caused by water impregnating a compromised LIB pack, can form hydrogen gas and chlorine gas. The rate of generation of these gases is found to be higher than when using fresh water.

From all the tests conducted during ELBAS, there is nothing to suggest that use of sea water makes the onboard firefighting work more dangerous as related to the risk for electrocution, despite the crew standing on a metal deck and using sea water for extinguishing.

3.6 Conclusions

Large-scale fires tests performed using a similar set-up with a similar methodology for triggering thermal runaway (TR) within the battery pack resulted in different fires. This showed the unpredictable nature of an EV fire and the wide range of the total spectrum of how the conditions might escalate during such a fire. These variations should be considered in designing safety systems for EV fires and when modelling EV fire scenarios.

Flame spread was one of the focus areas provided the tight stowage arrangements usually seen on vehicle decks on board ro-ro vessels. Flame spread among vehicles depends on parameters such as the flame length and radiation from the flames which can be unpredictable during an EV fire as mentioned earlier. Flame spread was also observed at different times into the fire ranging from a few minutes to flame spread not occurring 10 min after detection of the fire via the smoke detectors. The assumed 10 min of time taken for the shipboard firefighters to gear up and reach the fire becomes crucial as the shipboard firefighters might have to deal with a fire involving multiple vehicles by the time, they reach the fire.

Both direct and indirect cooling methods were tested within the experimental set-up. The usability of larger devices proved to be challenging due to the limited space around the stowed vehicles. The smoke layer descends to eye levels, which also poses additional challenges on locating the fire seat and maneuvering and handling the devices. These challenges were observed when hammering in the extinguishing lance into the battery pack and maneuvering larger devices.

Providing direct cooling on the battery pack was the most efficient way of cooling the battery pack down below TR with a lower water consumption. Providing cooling around the EV, contained the fire to the EV without flame spread to adjacent vehicles. However, the time of activation is key to ensure both methods achieve their goals. The water consumption was considerably lower for direct cooling methods compared to indirect methods. The amount of water used on a ro-ro ferry could be limited due to stability issues with the vessel. Therefore, the use of water efficient direct cooling on the battery pack and containing the fire with a non-water-based techniques (e.g., fire blankets) could limit the water consumption without reaching stability issues. Both direct and indirect cooling methods have their pros and cons but combining both methods proved to be a more efficient approach during the experiments.

Conventional smoke detectors installed on the ceiling were able to respond with alarms shortly after the smoke could be visible. Selective detection systems for HF also generated alarms but, based on the location of the detection system the times varied. The HF detectors placed inside the battery compartment gave the earliest detection as expected. But the aspiration system installed above the EV on the ceiling triggered after a longer time. Nevertheless, the readings from HF sensors showed the possibility of detection using selective HF detectors for an EV fire. Placement of smoke/ gas detectors should be done considering the ventilation and wind effects within the decks. Lower detection times can be achieved by proper placement of such detectors.

The ceiling of the experimental set-up (stainless steel) was protected with thermal insulation and during experiment 4, the ceiling was observed to be sagging some time into the fire which was then cooled down by the firefighters using water. The conditions just above the fire reached severe enough that, even with thermal insulation, the structure was affected during the fire. The uninsulated side walls of the set-up also

reached up to 600 °C of temperature during experiment 4 but direct cooling via water cooled the walls down with quick time.

3.7 References

- [1] "<https://www.consiliumsafety.com/en/>." <https://www.consiliumsafety.com/en/> (accessed Dec. 04, 2022).
- [2] "BridgeTech™ Car Fire blankets." <https://bridgehill.com/fire-blankets/car/> (accessed Sep. 29, 2022).
- [3] "E - Extinguishing Lance for Batteries User Manual." Murer - Feuerschutz GmbH, Apr. 2020. Accessed: Sep. 29, 2022. [Online]. Available: https://www.murer-feuerschutz.de/pdf/E-Loeschlanze_BA_EN_komplett.pdf?m=1643720561&
- [4] "Rosenbauer Introduces the Battery Extinguishing System Technology (BEST)," Rosenbauer, May 05, 2022. <https://www.rosenbaueramerica.com/rosenbauer-battery-extinguishing-system-technology/> (accessed Sep. 30, 2022).
- [5] "Product Data Sheet - Pendant Open Low Pressure Water Mist Nozzle (Model Suez & Panama OH-OPX1)." VID FireKill ApS, Sep. 24, 2021.
- [6] "Chameleon® Chemical Detection Armband," Morphix Technologies. <https://morphtec.com/products/chameleon-armband/> (ec. 06, 2022).

4 ELBAS – WP4: Fire Drills and Training

DEN DANSKE
MARITIME FOND



The Danish Maritime Fund –
Project number 2021-039

4.1 Introduction

The objective of this work effort was to examine current fire drills and training methods specifically related to fires on vehicle decks, identify future training needs, and help develop and perform specialized and realistic training for effective firefighting of vehicle deck fires.

4.2 Onboard Fire Drills & Training

The regulations and requirements related to onboard fire drills and for training of crew serving on passenger ships are contained in the International Maritime Organization (IMO)'s Safety of Life at Sea (SOLAS) Convention and in the Seafarers' Training, Certification and Watchkeeping (STCW) Code. SOLAS specifies the requirements for fire drills while the fire training certification requirements are set in the STCW Code.

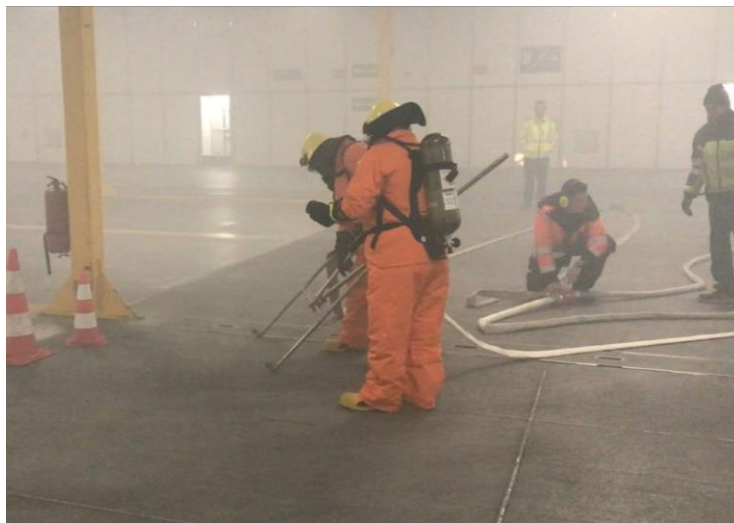

Figure 4.1: Onboard Fire Drill, including use of special cooling tool and smoke machine

4.2.1 Fire Drills

The SOLAS Convention states the requirements for Fire Drills in *Chapter III – Regulation 19.3.5 Fire Drills* which primarily focuses on checking and testing the readiness of onboard fire response and the firefighting equipment, to develop and maintain the crew's skills as preparation for a real situation.

While the SOLAS regulation specifies that *“Drills shall, as far as practicable, be conducted as if there were an actual emergency”* there are no detailed requirements in SOLAS for how drills shall be set-up. This is left to the responsibility of the individual shipping company to define a drill's contents and set-up through their Safety Management System (SMS) procedure.

In SOLAS, it is only specified that, *“Fire drills should be planned in such a way that due consideration is given to regular practice in the various emergencies that may occur depending on the type of ships and the cargo.”* (SOLAS Ch. III Reg. 19.3.5.1)

4.2.2 Training Requirements

The STCW convention specifies the required training and level of competence in fire prevention and fire fighting for maritime personnel as detailed in Chp. 6 Section A-VI/1 -- **Specification of minimum standard of competence in fire prevention and fire fighting** and Section A-VI/3 **Mandatory minimum training in advanced fire fighting**. Specifically, the STCW requirement states the following: - *The type and scale of the fire is promptly identified, and initial actions conform with the emergency procedure and contingency plans for the ship* (STCW section A-VI/3)

Additionally, STCW states requirements to be able to “Prevent, control and fight fire on board - Ability to organize fire drills, Knowledge of classes and chemistry of fire, Knowledge of fire-fighting systems, Action to be taken in the event of fire, including fires involving oil systems.” (STCW section A-VI/3)

Through the field work conducted in WP1 of the ELBAS project, several different onboard fire drills were observed. The drills included Emergency Mustering of crew dressed in SCBA firefighters’ outfits, which was carried out as per the ship’s Emergency Muster List, with a fire scenario of a simulated EV fire on a vehicle deck. The fire drill included the use of a smoke machine to provide the effect of impaired visibility and the seat of the simulated fires were inside of a luggage wagon. In both cases, firefighting teams in full bunker gear entered the vehicle deck to actively fight the simulated fire with charged fire hoses and other equipment. In addition, where practicable reduced lighting and obstacles were used, to simulate realistic conditions during an actual fire (see Figure 4.2.)



Figure 4.2: View during an onboard fire drill using (a) a thermal image camera and (b) regular field of view

The STCW requirement for live firefighting training includes demonstrating the ability to “*fight fire in smoke-filled enclosed spaces wearing self-contained breathing apparatus*”. (STCW Table A-VI/1-2) This general training requirement applies to all ship types, including both cargo and passenger ships.

All seafarers are required to complete such regular mandatory fire training courses on shore, including “smoke diving”, as well as Fire Team Leader courses for officers. However, there is currently no specific IMO / STCW requirement for specific training related to tackling vehicle deck fires onboard a ferry.

4.2.3 Realism of Shipboard Fire Drills

Shipboard fire drills are generally conducted on an empty deck, without vehicles, due to operational costs and constraints. These training simulations, as seen in Figure 4.3, provide vital response criteria such as firefighter response times, firefighter equipment readiness, fire protection system functionality, detection network responsiveness, and smoke/obscuration conditions during a fire event.



Figure 4.3: Fire drill onboard ship, with the use of smoke machines and charged fire hose lines

These fire drills are of course simulated and only mimic a fire scenario, to limit any hazardous exposure to firefighters, the ship, and the environment. This is accomplished by using a smoke machine rather than an open fire. In a realistic fire scenario, the responding firefighters will be exposed to additional obstacles such as excessive heat and smoke production from the fire, along with a maze of stowed vehicles. The stowed vehicles, shown in Figure 4.4, form narrow aisles of travel through the vehicle deck and present pinch points for the movement of a charged firehose lines.

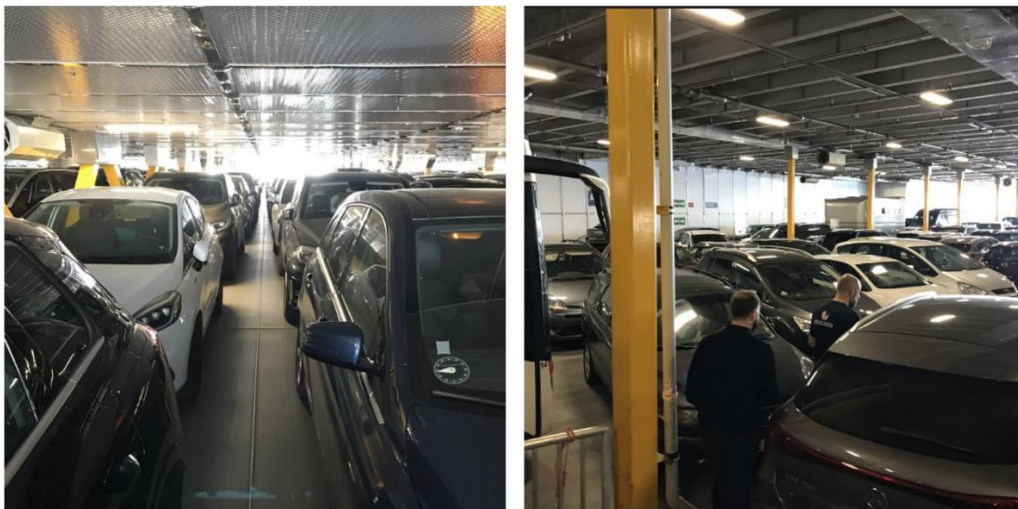

Figure 4.4: Examples of the tightly stowed vehicles on a fully loaded vehicle deck to highlight reduced mobility

4.3 Realistic Fire Training – Simulated Vehicle Deck with Real Cars

Modern vehicles pose newer risks and hazards in case of fire, including airbags exploding, greater use of integrated electronics, and increased use of plastics and fiberglass. This results in an increased formation of HF gases and generally a higher fire load than previous generations of vehicles. While fires in modern cars are rarer, the consequences can be more severe when they occur onboard a ferry, where both space and firefighting resources are limited.

To better address these obstacles, experiments were conducted through the ELBAS Project to simulate a realistic fire scenario aboard a fully loaded vehicle deck. The experimental set-up, shown in Figure 4.5, consisted of nine cars (8 conventional cars surrounding a single electric vehicle) placed within a structure built from ISO 40 ft shipping containers to simulate a vehicle deck. This type of fire testing, detailed in section [31] (WP3: Live Fire Testing), helped to test the applicability of various firefighting tools. Such an experience is not practicable to conduct during the onboard Fire Drills, nor is part of the mandatory STCW shipboard fire training.



Figure 4.5: Specialized Test and Training Set-up simulating a Vehicle Deck

4.3.1 Realistic Fire-training Set-up of a Vehicle Deck

Vehicle decks on ferries are often rather compact with vehicles usually stowed near each other. Furthermore, the ceiling height clearance on vehicle decks can be as low as just over 2 m. Therefore, the use of large fire extinguishing devices, navigation and maneuvering around in between the stowed vehicles can be an additional challenge for this unique environment. Therefore, the usability of these different firefighting techniques within such a confined space must be considered when conducting training and fire drills.

Considering the above challenges, a series of large-scale experiments with live fire performed under the ELBAS project described earlier in WP 3, where different firefighting devices and technologies were then put to test against an EV fire. During the final two days of testing, selected shipboard firefighters were given the opportunity to try out several of these devices and techniques in the experimental set-up, which was designed to represent the conditions and challenges when fighting a fire on a vehicle deck in a ferry at sea.

4.3.2 Simulated Vehicle Deck Set-up

The ELBAS test set-up was constructed at RESC in Slagelse, Denmark, and was designed to simulate the enclosed and compact nature of the vehicle deck. The ELBAS set-up provides simulated and realistic

conditions of a ferry vehicle deck, with the capability to train firefighting on real fires using real cars and inside a similar geometry to that normally found on a full vehicle deck with cars stowed tightly close to each other.

The main structure of the vehicle deck set-up consisted of combining two standard 40-ft ISO shipping containers, connected with steel plating with stowed vehicles inside, see Figure 4.6 and Figure 4.7.



Figure 4.6: Inside the Specialized Test and Training Set-up Simulating a Vehicle Deck



Figure 4.7: Initial Vehicle Fire in the Specialized Test and Training Set-up

4.3.3 Live Fire Training Course – Modern Vehicle Fires on a Vehicle Deck

Based on the experience gained in the ELBAS project a new training course, with focus on crew training of how to extinguish a fire in a modern vehicle on board a ship, has been developed, see Figure 4.8.



Figure 4.8: Realistic Live Fire Training of a Vehicle Deck Fire

This course provides shipboard firefighters with a more realistic training scenario for tackling a modern vehicle fire, such as in an EV, onboard a ship, in a shore-side test set-up resembling a ferry's vehicle deck with live fire using real cars.

Having a specialized fire training course for vehicle deck fires provides both theoretical knowledge and the practical skills, to assess and handle risks and dilemmas associated with extinguishing such fires.

In addition, protective equipment as well as the safe decontamination of emergency personnel is covered, to address the issue of toxic soot and residue on the fireman's outfit, specifically resulting from HF gases which could be released.

A pilot training course was conducted using the specialized test and training set-up, involving representatives from shipboard firefighting organizations including firefighters, see Figure 4.9.



Figure 4.9: Fully developed vehicle fire(s) in the specialized test and training set-up

Feedback received from the ship-based participants of the pilot course held during the ELBAS project, was very positive. The experience gained from training on real burning vehicles in a set-up, which resembles a vehicle deck, was unique and realistic of what might be encountered in a real situation onboard.

4.4 Joint Exercises – Shipboard & Shore Coordinated Response

The criteria listed in STCW (Section A-VI/3 Mandatory minimum training in advanced firefighting, 6.1.1.8) includes the requirement of “*procedures for coordination with shore-based fire fighters.*” These procedures typically consist of Point-of-Contact lists and details on available shore-side support, contained in the company’s SMS.

However, it is not always the case that full scale joint exercises are regularly held between the ship and shore-side emergency response services, and that in some cases land-based professional firefighters are not fully aware of the specific firefight procedures, training and equipment existing onboard.

In the case of an EV fire onboard, which may be challenging for the ship’s officers and crew to tackle alone onboard, an integral planning of a combined response with the assistance of shore-based fire fighters is highly recommended.

Traditionally, perhaps due to political reasons, various agencies have not engaged in such dialog, due to different laws and regulations applicable to each area (maritime vs. shore-based emergency response). Benefit can be had by developing cooperation agreements with external authorities, to ensure holistic contingency planning and coordinate cross-disciplinary exercises with the local emergency services.



Figure 4.10: Onboard Fire drill with use of a smoke machine and charged hose lines

By engaging with local shore-side emergency services, challenges can be identified and addressed, and contingency plans developed to be best prepared for an EV or other fire incident onboard. It would be advisable to invite for knowledge sharing and a preparedness exercise with emergency managers, to help increase awareness of specific shipboard installations, available firefighting equipment and SMS procedures in use onboard. The advantages of involving the local shore-side emergency services in the planning of shipboard emergency response procedures helps ensure the best congruencies when dealing with an EV fire situation, which potentially may develop into a larger incident requiring assistance from shore.

4.5 Conclusions and Recommendations

Fire Drills provide the opportunity to test response times and for the checking of readiness of firefighting equipment and functioning of fire systems onboard. However, such drills may only be of limited value to prepare for a real-life situation of an EV Fire onboard. It is important to perform as realistic training exercises as possible, as this may help to reveal any issues in how specialized firefighting equipment is used.

It is recommended to work with local emergency services and first responders, to transfer and develop existing knowledge of EV-specific firefighting from ashore over to the maritime sector.

Realistic firefighting training of maritime personnel is essential. In general, it is recommended that, based on the observations and experiences from ELBAS project, crew members would benefit from more live fire training or realistic drills involving a fire on a vehicle deck – to experience the difference between a conventional car fire and EV fire, for instance.

Effective drills shall incorporate socio-technical elements combining both human and technical aspects, in order to effectively manage a fire onboard.

When a fire occurs on a vehicle deck, the location of the fire's origin is less critical in the early stage of firefighting. It can be assumed that any fire on the vehicle deck is a battery fire and therefore appropriate precautions shall be taken for such a type of fire.

The following elements are recommended to include in fire training for vehicle deck fires:

- Training on use of **CCTV** as a fire detection and verification of a fire, thus potentially improving response timing to the fire,
- Use of **Sprinkler/ Drencher/ water-mist system** – Training on effect and use strategy during a fire incident
- Proactive use of Smoke management strategy, including active use of ventilation, as part of the decision support tools (CFD).
- Shipboard firefighting theory related to topics such as: smoke toxicity, sprinkler and ventilation zones, ship stability, etc.
- Better understanding of the benefits of using water to dilute toxic smoke and gases.
- Importance of post fire drill **Debrief**, which can be used to address facts surrounding battery fire, toxic gasses, and smoke movement,

EV fires on ferries are not to be feared more than any other fire at sea. They can typically be dealt with using the correct technology, education, and training of shipboard personnel, as well as with coordinated cooperation between the ship and shore-side emergency services.

5 ELBAS – WP5: Conclusions and Recommendations

DEN DANSKE
MARITIME FOND



The Danish Maritime Fund –
Project number 2021-039

5.1 Conclusions

This chapter summarizes the findings of the ELBAS project, giving the overall perspective of the problem of handling EV fires on board ferries, as gathered during this study. The reader is referred to the respective sections of the full report for comprehensive insights concerning these conclusions.

The overall conclusion of the ELBAS project is that EV fires on ferries are not to be feared more than any other fire at sea. They can typically be dealt with using the correct technology, education, and training of shipboard personnel, as well as with coordinated cooperation between the ship and with emergency services on land.

Extra attention should be paid to training of crew on ships carrying electric and other modern vehicles, through performing realistic drills involving vehicle deck fires, and including the appropriate protection and correct disrobing procedures post fire, to avoid harmful contamination from chemical exposure.

For portable firefighting tools to work, their operation must be included when developing vehicle stowage procedures for loading the vessel, in order to have any effect with the fire.

5.1.1 Results of the Live Fire Tests and Fire Simulations

The use of portable fire extinguishers alone is not as effective as the use of fixed, water based firefighting systems. Cooling is key and use of sprinkling with a water mist turned out to be highly effective. Not in fully extinguishing an EV fire, but for limit the spread of the fire, so that the shipboard firefighters can get to seat of the fire and continue extinguishing with traditional extinguishing methods, possibly combined with appropriate specialized tools.

ELBAS results have also demonstrated how fire simulation can give insights into how fire and smoke can spread within a ro-ro vehicle deck, and how current fire protection methods e.g., detection and suppression, perform given different simulated scenarios of an EV fire.

5.1.2 Active Use of Ventilation as part of a Fire Management Strategy

Keeping the ventilation system running (jet fans) may have positive effect for smoke control during a fire on the vehicle deck in certain scenarios and could be considered as part of the fire management strategy. Simulations using advanced fire modelling tools can be very useful to identify issues and behavior of fire and smoke, but the results of such simulations are dependent on the specific ship geometries and loading conditions modeled.

The results presented in this report are based on case studies of two of the ships included in the ELBAS project, and, therefore, any generalizations should be done with care. It is therefore recommendable to perform this type of study on more ships, to better quantify this, and inform owners and the shipboard officers and crew of the specificities of their ship.

5.1.3 Use of Fixed Sprinkler (Drencher or Water Mist) System Provides a Quick Response

Early sprinkler activation is the key to stopping the fire spread. While a drenched or water mist system will not necessarily target the battery directly of the EV, it will produce a spray once activated from its fixed position causing a cooling effect, both on the burning car itself and to the surroundings including nearby structural elements. As soon as the fixed system in the ELBAS tests was activated, a drop in temperature on

the battery, smoke layer above the EV and the surrounding cars were observed, helping to contain the fire and prevent spread.

5.1.4 Large Thermal Fire Blanket Over Vehicle

The use of a large thermal fire blanket to enclose the car has shown to be effective, especially when combined with the other efforts of using both fixed firefighting installations supplemented with manual firefighting are combined. While use of a fire blanket alone did not put out the fires in the ELBAS tests, the fire blanket did an effective job in containing it, by removing oxygen and preventing fire spread.

It is also conceivable that cars surrounding the burning EV could be protected by fire blankets, to prevent the additional spread of fire. The fire blanket's main purpose is to limit the flame spread to adjacent vehicles or to the structural elements and provide enough time for the vessel to reach port and get external shore-side assistance.

However, use of a fire blanket requires space to wrap the burning EV correctly and a minimum of two persons in appropriate PPE, so this solution depends on how close the cars are stowed onto the vehicle deck. On a smaller ferry with few vehicles and crew, fire blankets could be a helpful tool as a supplement to the existing firefighting arrangement. Whereas in larger fires and/or tightly stowed vehicle decks which limits direct access to the fire, use of fire blankets may not be as effective given the restricted space available.

5.1.5 Battery Extinguishing Systems

Two methods for direct battery extinguishing were tested as part of the ELBAS project. Direct cooling of the battery is advantageous and extremely efficient when controlling a battery fire, and the battery pack was cooled down with a considerably lower water consumption compared to other water based extinguishing systems used in ELBAS series of experiments. However, these devices are not capable of putting out flames inside the passenger cabin or vehicle itself.

These devices are most appropriate when only the actual battery itself is the concern. It is therefore required that the flames outside the battery have been put out prior to using this device. This makes it much easier for the firefighters to attack the battery without the effects from external flames and smoke. The intended use of these devices is primarily to cool down the battery after the fire has been extinguished, and given the complexities of use, may be most appropriate for use by professional firefighters with proper training with battery and battery fires.

5.1.6 Portable Mist Curtain and Undercarriage Cooling

Several portable firefighting tools producing a local water mist curtain were tested as part of the ELBAS live fire experiments. This water curtain is to act as a barrier for flame spread and keeps the fire contained within the originally ignited vehicle.

Each of these devices must be connected to the water supply using a standard fire hose found onboard, before placing it near the burning vehicle. These systems provide local water cooling on either the sides of the burning vehicle and/or in a smaller array underneath the burning EV where the batteries are normally located. The intention is to create a water barrier around the EV, through which heat and flames cannot penetrate and spread.

The use of such portable mist cooling devices may assist in keeping an EV fire from growing and spreading, until the ship reaches port. However, these devices must be placed prior to the fire spreading, and depends on how close the cars are stowed on the vehicle deck, as it required sufficient clearance around the vehicles.

For all these portable firefighting tools to work, their operation must be included when developing vehicle stowage procedures for loading the vessel, in order to have any effect with the fire.

5.1.7 Combined Firefighting Methods

The combination of using the fixed firefighting installations supplemented with manual firefighting from the crew on board is the most common fire strategy for first response to an EV fire onboard. Early response and cooling are key for the fire not to spread or to develop further. These are critical measures to be taken onboard to protect the ship, it's passengers and crew while heading to the nearest port where emergency services can provide assistance.

It is known from research of actual events and experience from the ELBAS live fire testing that fire in an EV battery can flare up again after a period of time. Thus, achieving complete extinguishing of such EV fires may be too much to expect from shipboard firefighters, who may have only limited live fire experience for the statutory maritime fire courses required by STCW and the Flag State. Therefore, it is important to engage with available local shoreside firefighters in the planning for potential occurrence of an EV fire onboard.

5.1.8 Specialized Fire Training

Realistic firefighting training of maritime personnel is essential. In general, it is recommended based on the performance of the ELBAS project, for crew members to do more realistic fire drills and possibly training involving live fires using real cars in a set-up resembling a vehicle deck – to experience the difference between tackling a conventional car fire and EV fire, for instance.

Part of this specialized training should also include use of correct PPE, both for the shipboard firefighters and the crew with emergency duties as assistants, to avoid post fire contamination. Further, it should be encouraged to include a decontamination step in the post-fire clean-up procedure. Such training can also be done in cooperation with shore-based firefighters.

5.1.9 Joint Exercises and Drills with Shipboard and Shore-side Firefighters

All fires onboard ships present a challenge for the ship's crew, not least a fire on the vehicle deck. In the case of an EV fire onboard, an integral planning of a combined response with the assistance of shore-based fire fighters is highly recommended. Through working together with local emergency services and first responders, it is possible to transfer existing and develop knowledge of EV-specific firefighting from ashore over to the maritime sector.

Full scale joint exercises should be held regularly, between the ship and shore-side emergency response services, in order to identify potential opportunities for improved cooperation and coordinated response. Through interviews it was found that, in some cases shore-based fire fighters are not always fully aware of the specific firefight procedures, training and equipment existing onboard ships.

5.1.10 Need for a Regularly Updated Fire Risk Assessments

The requirement for assessment and management of risks is one of the fundamental Objectives of the ISM code (Part A, 1.2.2) Regular risk assessments shall be carried out to see how accidents, injuries or illnesses

could be caused on the ship and what can be done to reduce the chances of them happening. Risk assessments should be reviewed annually, as well as whenever there are significant changes to either the ship or working activities onboard.

With the increase in transportation of new fuel vehicles, including EVs, updated Risk Assessments are required to identify these new risks, and new procedures developed to address them. These are also a focus point during port and flag state inspections, as well as by other inspection authorities, and need to be developed by the ship's master with the support of the crew, the shipping company and other relevant safety experts.

While the carriage of EVs is no more dangerous than the carriage of ICE vehicles, the dangers they pose are different and the consequences of a fire are potentially more severe. Stakeholders should ensure that those dangers are identified, discussed and mitigated appropriately and incorporated in new procedures addressing these risks.

5.1.11 Crew Size Impacts Available Response

Day ferries on shorter routes typically operate with fewer crew onboard than longer and overnight ferry routes. Therefore, they are often more reliant on the use of the fixed firefighting systems found onboard, as they may not have sufficient manning or equipment to perform effective manual firefighting operations, or use specialized firefighting tools. It is therefore of even greater importance for such ferry operators to engage in a dialog with and include available shore-side emergency services, in the response plans for a possible EV fire onboard.

5.2 Recommendations

This section summarizes the recommendations of the ELBAS project from each of the WPs as gathered during the study. The reader is referred to the respective sections of the report for comprehensive insights concerning these recommendations.

5.2.1 WP1 Human Factors - Recommendations

The recommendations and conclusions presented below are based on the field work performed onboard the three ferry types and presented in this report. Therefore, any generalizations should be done with care.

The challenge of fighting fires in EVs and modern vehicles is a socio-technical problem that requires broad solutions beyond what can be delivered through technical solutions. It is recommended that the individual is taken into consideration when evaluating how to best fight EV fires. Early detection is key to getting to fighting the fire before irreversible damage has been caused. Detection systems including suitable CCTV can help provide early detection. The ability to operate the ship's firefighting systems from the bridge can help with an early response to EV fires. Any time spent identifying the source of the fire and taking the proper steps to mitigate the situation will influence the outcome of the firefighting.

Extra attention should be paid to training and education of personnel on ships carrying electric and other modern vehicles. Regular exercises developed by the individual operator will allow the crew to experience vehicle fires first-hand and are recommended to prepare them for what to expect in a real fire event. This also gives the crew the ability to try correct disrobing procedures to avoid harmful contamination from

chemical exposure. At the end of such a live fire exercise, the personnel should be instructed in how to handle the vehicle to prevent reignition which is occasionally seen in EVs.

Decisions in relation to use of the ventilation system are currently taken according to procedure or individual assessments on the bridge. An overview of predicted effects of smoke movement and ventilation behavior in case of a fire would be a good tool to aid in this decision-making process. This overview can be provided through a risk assessment of the individual ships with appropriate simulations.

5.2.2 WP2 Technological Aspects – Recommendations

The recommendations and conclusions presented below are based on the two case studies presented in this report. Any generalizations should be made with care. There is a need to perform this type of study more often, to better quantify and inform owners and the crew of the specificities of their ship. Results presented in this section are based on the detailed analysis outlined in greater detail in section 6 (**ELBAS Appendix - WP2: Technological Aspects - Fire Scenarios and Technologies**).

Within the world of Fire Safety Engineering (FSE), there are specifically design computational tools that allow FSEs to run fire scenarios and investigate the potential risks, consequences and life and property safety. The use of these tools is common practice in the design of buildings. However, this type of fire and life safety analysis seems to have found little traction in the maritime industry, even though these tools, typically implementing a form of computational fluid dynamics (CFD) simulating smoke and fire development, would be applicable to e.g., ships just as much as they are used for buildings.

Keeping the ventilation system on (jet fans) may have positive effect for smoke control during a fire, especially on a high-speed ferry's higher car deck (tier 2). On the closed vehicle deck, ventilation during the fire may be dangerous and may lead to a fire spreading after 10 minutes. The advantage of using fire simulation tools is that large potential fire scenarios can be investigated without having to perform full scale tests. It is recommended to perform CFD simulations for each specific loading case and ship arrangement, as the results will depend on both the vessel's and the specific vehicle deck's geometries.

Detection time for a slow growing EV fire often observed in large-scale tests can be longer (double, compared to a fast-growing fire), thus development and testing of alternative early detection methods is recommended. In tests, the detection times may be influenced (longer) when the ignition car is placed in vicinity of ventilation outlets. Thus, considering the specific placement of EVs could be helpful.

In low season, cars should be distributed along all decks, to minimize the risk of fire spreading to adjoining cars. A larger gap between two cars means that the flame spread might take longer allowing more time for the crew to muster and gear up before fighting the fire. The time the crew has before the fire spreads to neighboring vehicles may vary between 2 to 6 minutes depending on the specific ship type and location of fire, according to tested scenarios.

Exposed and uninsulated aluminum structures on the high-speed craft can reach critical temperatures from 5 to 18 minutes after the fire starts, depending on the fire location and time for activation of the sprinklers. This can result in a structural failure or that a car falls on another deck if no cooling action is taken and the fire is allowed to burn. Protection of structures that can be exposed to fire is recommended.

Early sprinkler activation is the key to stopping the fire spread. Simple and clear procedures should be developed for this purpose. In cases where drencher zones are not following the flood control door zones (often found on older ro-ro passenger ships due to water-on-deck stability concerns), the decision on the systems activation should be supported by information on sequence of the detection activation combined with visual inspection, to determine the correct zone of the fire.

5.2.3 WP3: Live Fire Testing - Recommendations

The recommendations and conclusions presented are based on the nine large-scale live fire tests performed during the ELBAS project and presented in this report. All generalizations should be made with care.

Large-scale fires tests performed using a similar set-up with a similar methodology for triggering Thermal Runaway (TR) within the battery pack resulted in different fires. This showed the unpredictable nature of an EV fire and the wide range of the total spectrum of how the conditions might escalate during such a fire. These variations should be considered in designing safety systems for EV fires and when modelling EV fire scenarios.

Flame spread was one of the focus areas given the tight stowage arrangements usually seen on vehicle decks on board ro-ro vessels. Flame spread among vehicles depends on parameters such as the flame length and radiation from the flames which can be unpredictable during an EV fire as mentioned earlier. Flame spread was observed at various times during the fire, ranging from a few minutes up to 10-min, after the fire was detected via the smoke detectors. In other cases, flame spread did not occur.

Both direct and indirect cooling methods were evaluated within the experimental set-up. The usability of larger portable firefighting devices proved to be challenging due to the limited space around the stowed vehicles. The smoke layer descended to eye levels, which also posed additional challenges on locating the fire seat and maneuvering and managing the devices. These challenges were in particular, observed when hammering in the extinguishing lance into the battery pack and when maneuvering larger firefighting devices.

Providing direct cooling on the battery pack was the most efficient way of cooling the battery pack down below TR with a lower water consumption. Cooling around the burning EV prevented flame spread to adjacent vehicles. However, the time of activation is key, to ensure these methods achieve their goals.

Water consumption was lower for direct cooling methods compared to indirect methods. Lower water consumption used for shipboard firefighting is always desirable, due to stability considerations. Water efficient direct cooling on the battery pack, and containing the fire with a non-water-based techniques are both examples of limiting the water consumption. Both direct and indirect cooling methods have their pros and cons but combining these methods showed to be effective during the ELBAS experiments.

Smoke detectors installed on the ceiling were able to respond with short detection times after smoke could be visibly observed. Selective detection systems for hydrogen fluoride also generated alarms, however the location of the detection system impacted their effectiveness.

5.2.4 WP4: Fire Drills and Training - Recommendations

The recommendations and conclusions presented are primarily based on observations made during the fire drills performed onboard and the live fire training with actual cars conducted during the ELBAS project, and which are presented in this report. All generalizations should be made with care.

Onboard fire drills provide the opportunity to test response times, checking of readiness of firefighting equipment, and the functioning of fire systems. However, such drills may only be of limited value to prepare for a real-life situation of an EV fire onboard. It is important to perform as realistic training exercises as possible, as this helps to reveal any issues in how specialized firefighting equipment is used and gives the crew confidence in their skills and in the firefighting procedures. The intention of advanced training on firefighter tactics for EVs is to shorten the time for fire crew response and improved overall preparedness.

The following recommendations are made for fire drills and training related to onboard EV fires:

- Training for fire fighters and their assistants, in correct use of **PPE and decontamination** post fire,
- Perform specific training on the effective use of **CCTV** as a fire detection and verification of a fire, thus potentially improving response timing to the fire,
- Proactively use of a **Smoke Management Strategy**, including active use of ventilation, as part of the decision support tools based on CFD fire simulations,
- **Sprinkler/drencher/water-mist system** – general training on the effectiveness and strategy of using the system during a fire incident – theory related to toxicity, stability, sprinkler zones, etc. Better understanding of the benefits of using water to dilute toxic smoke and gases.
- **Realistic fire training** – FF training using a simulated vehicle deck set-up with real cars, realistic firefighting training of maritime personnel is essential. Crew members should be provided with more realistic training or realistic drills – to experience differences between conventional car fires and EV fires, for instance.
- **Effective drills** should incorporate socio-technical elements, in order to effectively manage a fire onboard.
- **Debrief** – Expand post fire drill debrief, to include facts surrounding battery fire, toxic gasses, and smoke movement.
- Perform **joint exercises**, involving both shipboard and shore-side firefighters - It is recommended to work together with local emergency services, first responders, and national authorities to exchange and develop existing knowledge of EV-specific firefighting from ashore over to the maritime sector.

This specialized training will often go above and beyond the statutory requirements, as prescribed in SOLAS, STCW, etc.

5.3 Misconceptions and Myths

In addition to testing specific technologies and techniques, the many tests performed in ELBAS help to confirm or disprove some of the misconceptions and myths associated with fires in EVs onboard ships. For example:

5.3.1 Risk of Electrocutation due to use of Sea Water as Extinguishing Medium

“It is more dangerous to put out an electric car fire on board a ferry than on land, because the crew stands on a metal deck and use salty sea water for extinguishing.”

From all the tests conducted during ELBAS, there was nothing to suggest that use of sea water makes the onboard firefighting work more dangerous. In addition, no reported cases have been sighted providing any evidence to support the theory that there exists an increased risk of electrocution via the water stream.

5.3.2 Increased Heat Under an EV

“There is a greater risk onboard High-Speed Craft of damage to the aluminum deck below a burning EV, due to the high heat generated by an EV battery fire.”

Since the battery pack is typically located at the bottom of an EV, there has been concern that a fire might even melt the decks of aluminum ferry. While this may be the case if the EV is left unattended and burns in the same location for several hours straight, the ELBAS tests indicated that the heat impact from the bottom of the car is not so severe, that it would damage or even melt the vehicle deck.

When the burnt EV was removed, there was little evidence of the fire on the steel plates representing the vehicle deck.

5.3.3 Are EV Fires Manageable?

“It is not possible to control an EV battery fire.”

While the carriage of EVs is no more inherently dangerous than the carriage of ICE vehicles, the fire risks they pose are different and the consequences potentially more severe if not addressed adequately. From the new knowledge and experience gained in ELBAS, through the 9 live fire tests involving an EV traction battery, it can be concluded that, EV fires can be managed with the proper procedures, equipment, and training.

5.4 Dissemination Activities

The ELBAS project has attracted an enormous amount of interest, starting from even before the project began and continuing throughout the period in which it was conducted. This interest has been from both Danish and international stakeholders, emphasizing the importance and relevance of this challenge.

Given the topic’s relevance and high level of interest in ELBAS, dissemination activities have taken place throughout the project. This has included presentation at workshops, seminars, and conferences, taking place in both maritime and fire safety forums. Additionally, a number of articles have been published with focus on the ELBAS research, both in relevant Danish and international media.

5.4.1 Table of ELBAS Activities

Key dissemination activities are listed in the table below. This list is not all inclusive, and includes presentations on ELBAS activities at conferences, workshops, and seminars.

Table 5.1: List of ELBAS Publicity Activity

Activity	Presentation Title	Conference or Workshop	Date
Danish Shipping - Ferry Group	Fires on vehicle decks (<i>Brand på vogndæk</i>)	Workshop	2022/03/09
IDA Maritim/STSF - Danish Engineering Society/ Danish	Electric Vehicle Fire Safety at Sea - ELBAS, LASH FIRE	Conference	2022/04/04

Society of Naval Architecture and Marine Engineering			
MarNav - Marstal School of Navigation	ELBAS presentation at FIREFIGHTING of EVs ONBOARD FERRIES (<i>Brandslukning i elbiler på færger</i>) – Course and Workshop	Workshop	2022/05/17
DBI – The Danish institute of Fire & Security Technology	EV Firefighting tactics and fire behavior at Professional development day for Danish police and insurance companies	Workshop	2022/09/15
RESC – Rescue & Safety Center, Korsør, Denmark	Fires and accidents with electrical vehicles – Emergency Services East & Slagelse Municipality Fire and Rescue (<i>Brande og uheld med el-biler - Beredskab Øst & Slagelse Brand og Redning</i>)	Workshop	2022/10/05
CFIS 2022 – Conference on Fire Safety at Sea, EMSA	Electric Vehicle Fire Safety at Sea (ELBAS) – 2022 LASH FIRE public conference, Lisbon, PT	Conference	2022/10/11
Society of Danish small island ferry operators – annual meeting (<i>Årsmøde i Småøernes Færgeselskaber</i>)	Presentation of EV Fires onboard ferry vehicle decks – Esbjerg, Denmark	Conference	2022/11/09
UK-AFI (IAAI Chapter 67) Annual Training Conference	Presentation of ELBAS work - Findings from full scale fire tests involving electric vehicles	Conference	2023/01/31

5.4.2 List of Articles Exposing the ELBAS Project

The ELBAS project has experienced a broad and industry wide (global focus) interest, throughout the duration of the research project, and has been the featured topic in both Danish and international journals and publications.

The following is a list of published articles featuring exposés of the ELBAS Project:

- Brand & Sikring – 3.2021 - **Færger skal sikres mod BRAND I ELBILER** (pg.54-56)
- SØFART – Nr. 32 - 4. oktober 2021 – **Det er urealistisk at slukke en batteri-brand i en elbil om bord på en færge** (pg.16-17)
- Brand & Sikring – 2.2022 - **Brandtest giver ny viden om batteribrande i elbiler på færger** (pg.13-17)
- SHIPPAXInfo – April 2022 issue **The Lithium Ion Challenge** (pg.19-22)
- UK FPA’s journal, Fire & Risk Management – October 2022 issue **High seas e-car risk** (pg.54-56)
- Online Article Postings:
 - CFPA website – July 2022, New knowledge about battery fires in electric cars on ferries:- <https://cfpa-e.eu/new-knowledge-about-battery-fires-in-electric-cars-on-ferries/>
 - Nautilus International website - 4 August 2022, Electric vehicle study addresses ferry fire fears: <https://www.nautilusint.org/en/news-insight/telegraph/electric-vehicle-study-addresses-ferry-fire-fears/>
 - CEPREVEN (ES) website – 26 August 2022, Detección y extinción de incendios de baterías de coches eléctricos en las cubiertas de vehículos de los transbordadores : -

<https://www.cepreven.com/deteccion-y-extincion-de-incendios-de-baterias-de-coches-electricos-en-las-cubiertas-de-vehiculos-de-los-transbordadores-924>

5.5 Further Research Recommendations

The following section focuses on recommendations on areas for further research through future work.

Human and organizational factors and their respective roles in EV fire incidents.

Interview more and a wider range of stakeholders – this is already ongoing and should continue after the end of the ELBAS project but should also be a feature of any future projects. The recommendation here would be to broaden the scope and include topics such as alternative fuel and other modern vehicles.

Future work and collaboration with selected industry partners, including ship-owners – this is also ongoing and will continue after the project. This will help with a greater understanding of the problem, getting more concrete with certain issues and solutions with selected partners.

Fire Modeling and Smoke Development Simulations

It is recommended to perform simulations for each specific loading case and ship arrangement, as the results will depend on both the vessel's and the specific vehicle deck's geometries. No two ships are entirely the same and certain loading conditions may influence risk of fire development and spread. Fire simulations can help identify situations where ventilation can be beneficial for smoke control.

Additional topics for further work

- Use of ventilation as an active firefighting strategy for smoke control
- Use of ship systems to assist with firefighting tactics, including CCTV, communications, compartment openings, movement of personnel and guests,
- Improved detection capabilities onboard vehicle decks,
- Improvements to water-based lithium-ion battery (LIB) firefighting systems
- Material identification and response capabilities onboard ships
 - Materials: plastics, alloys, refrigerants, electric mobility devices, etc.
- Post LIB fire management procedures,
- Fire Safety related to other types of alternative fuel vehicles carried onboard.
- Toxic gas exposure risks to Firefighters
- Specialized Training Course Content, including:
 - In-depth live fire training for ship personnel
 - In-depth live fire training for shoreside personnel
 - In-depth live fire joint training seminar with both ship and shoreside personnel
- Investigation into effectiveness of on-board safety drills (use of debrief and meetings to disseminate latest information and lessons learned, cabin searches - child vs adult in cabin)

5.6 Going Forward

The overall conclusion of the ELBAS project is that EV fires on ferries are not to be feared more than any other fire at sea. They can typically be dealt with using the correct technology, education, and training of

shipboard personnel, as well as with coordinated cooperation between the ship and with emergency services on land.

The following conclusions regarding EV Fires can be drawn based on analysis of all data from the respective tests used for validation of the CFD simulations developed to simulate fire spread on board:

Firstly, the battery pack in a new EV is significantly more firesafe than in an old one. When short-circuiting the battery cells in a Renault Fluence, the entire battery burned. When ignited a newer Tesla Model 3, only that specific battery cell bank burned.

Secondly, the positive message is that fires in EV on board ferries are manageable and are not something we should necessarily fear more than any other type of fire. All the fires in the ELBAS tests could be extinguished safely, so with the right firefighting technologies on board, the right training of the crew and a well-coordinated cooperation with the emergency services on land, EVs should not pose an increased safety problem in ferry traffic.

Given the many companies across the Blue Denmark who have important roles to play in the battery safety value chain, DBI believe there exists a great potential here in Denmark, to impact and improve EV fire safety and the ships which carry them in operation all around the world.

DBI continues to work and collaborate with industry partners, including ship-owners, manufacturers of equipment, maritime training facilities, ship designers and consultants, on the important issues related to EV fires at sea, fire safety related to Power-to-X and other alternative fuels. This effort is ongoing and will continue after the ELBAS project.

DBI sees the ELBAS project as just the beginning, and that ELBAS confirms the need for further research into these important fire safety topics.

6 ELBAS Appendix - WP2: Technological Aspects - Fire Scenarios and Technologies

DEN DANSKE
MARITIME FOND



The Danish Maritime Fund –
Project number 2021-039

6.1 Limitations and Assumptions

Design fires include assumptions listed and discussed below:

- The geometry of the vehicle deck is made based on drawings provided and measurements made during the ship visits. Certain simplifications were necessary and are not considered critical for the smoke and temperature results. Namely, the details of the piping and other equipment on the walls were ignored. The choice was made to take account of ceiling beams only, as these are known to obstruct and impact the smoke movement dynamics.
- The temperature inside the vehicle deck is assumed to be 25 °C although temperatures and humidity may vary throughout the year.
- Mesh sensitivity study was limited to meshes of 20x20x20 cm, 20x20x10 cm and 10x10x10 cm due to the large size of the computational domain. A study using 5 cm mesh would make the computational time unreasonably large. Combining meshes of different sizes was not suitable, due to the ventilation set-up.
- In practice, car fires provide inconsistent results due to the many uncertainties associated with car fires. This is true even when burning two identical cars in similar test parameters. However, when modelling these fires some boundaries to fire behavior of various types of vehicles need to be set to begin analyzing the problem. In this project, cars have been categorized into 4 categories based on their weight. This was done since a correlation between car weight and car energy potential was observed in literature.
- The weight distribution of cars at any time onboard is taken from statistics of car distribution from a typical car park scenario based on previous work done at DBI and assumed to be representative for the case at hand. Car-weight distribution statistics are not readily available for the ferries.
- The space between the cars varies depending on how many cars are to be loaded onboard and on the car deck officer leading the work. Some officers load the cars through one port, others through another, which creates two different situations. The distances between the cars in one lane (front to bumper) was assumed to be 20 cm, which is limited by the size of the mesh. Two distances between the car's sides were tested: 20 and 40 cm. The distance between the lane separation lines and the chosen width of the vehicle (1.8 m) dictates the distance (1.2 m) between the neighboring cars.
- Drains are assumed to be closed in the simulations because the water lock will not allow free air intake. Drains will be opened only during the time when the water triggers the opening mechanism. Such drains are not completely airtight but modelling these drains may create unrealistic flows in critical areas near a fire.
- Fire behavior of cars depends on many uncertain factors (state of charge, amount of fuel present in the tank, type of the car, starting location of the fire, number of plastics and other combustibles present in the car, windows being open, partially open or closed, age of the car, weight of the car etc.). Therefore, conclusions that are made in this report will have a degree of uncertainty and should only be regarded as indicative rather than exhaustive.
- Research has shown that the heat release rate of electrical vehicles is like conventional vehicles. Therefore, only differences explored relate to higher yields of hydrogen fluoride and early release of hydrogen for purposes of detection.
- Visibility is used as a measure of the level of toxic gases due to high uncertainty in FDS measurements. It is assumed that once the visibility is below 10 meters then the toxicity level also becomes untenable.

6.2 Car Categorization

There are multiple approaches in modelling of burning vehicles. Research has shown that when a fire spreads between the cars is of interest, a detailed modelling of car parts does not bring benefits to the overall picture [1]. Additionally, full-scale EV fire tests and comparisons to conventional vehicles have shown no large differences regarding peak heat release rate and total heat release. It is the fire scenario and the vehicle model this was found to be the most influential factor [2]. Heat release rate (HRR) curves have been determined and modelled for each of the car categories. Not all the cars burn in the same way, neither do they reach their peak HRR values in all cases, due to many reasons. Nevertheless, it was decided to take a conservative approach, and imagine the worst possible fire scenario for each of the vehicle categories.

Joyeux [3] proposed an introduction of vehicle classification which is based on its calorific potential (i.e., energy potential) which is proportional to vehicle’s mass. The classification system proposed by Joyeux is compared with the classification system introduced by American National Standards Institute (ANSI) and given in NFPA report 31, which is based on the curb weight of a passenger vehicle. Curb weight is defined as the total weight of a vehicle with standard equipment while not loaded with passengers and cargo.

Based on these categorizations and observing a direct relation between car weight and its energy potential, it has been decided to divide cars into four categories for the sake of this study, namely categories: 2 (light), 3 (compact), 4 (medium) and 5 (heavy) see Table 6.1. The lightest car category (category 1 - cars less heavy than 1000 kg) has been ignored and included in the car category 2.

Table 6.1: Car category based on the weight mass range

Car category	Mass range [kg]	Total heat released [MJ]
2 (light)	<1300	7500
3 (compact)	1300-1500	9500
4 (medium)	1500-1700	12000
5 (heavy)	>1700	12000

The car categories 4 and 5 have the same energy potential, because 12000 MJ is seen as a maximal potential energy stored within a vehicle. The difference between categories 4 and 5 is the weight, which correlates with burning duration, thus cars from category 5 will burn longer than cars from category 4.

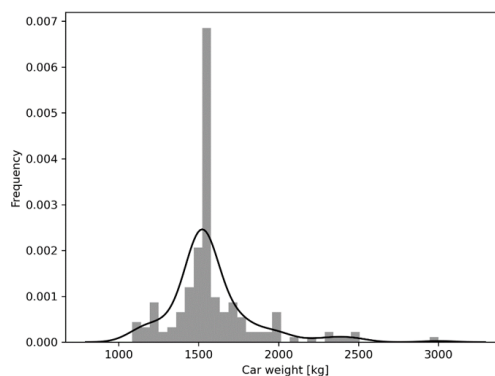

Figure 6.1: Statistics of car weight recorded at a car park (based on 354 cars)

Statistics from a large parking lot (based on 354 cars) show distribution of the car weight, Figure 6.1. The weights are close to normal distributed and there are no cars less than 1000 kg. There is only one car that is close to 3000 kg. The average weight is 1585 kg.

6.3 Design Fire

Several parameters are needed to describe fire behavior of a single vehicle and represent it with an appropriate computational model:

- Fire growth coefficient
- Fire decay coefficient
- Burning duration
- Peak Heat Release Rate (peak HRR)
- Critical ignition temperature of the vehicle

According to the NFPA classification [4], combustibles can be classified in several categories based on how fast the heat develops once they have caught fire. Those classes are namely: “slow”, “medium”, “fast”, and “ultra-fast” growing fires. Most of the literature indicates that vehicle fires do not normally experience a particularly fast fire growth. In fact, most of the vehicle fires grow following a so-called “slow” or “medium” fire growth, but it is important to note that this comes from older vehicle fire tests. Modern vehicle fire tests yielded HRR curves with growths like “fast” growing fire [5, 6], therefore when selecting appropriate design fires for the cars, it was decided to treat all cars as combustibles with “fast” fire growth. Fast growing fires are characterized with a fire growth coefficient $\alpha = 0.047$ [kW/s²], 150 seconds to reach 1055 kW.

Fire decay can be described using several methods. The most appropriate method for cars of our interest based on the exponential decay [6]. This method uses an exponential law to characterize the decay phase of the heat release rate curve from experiment data such that:

$$\dot{Q}(t) = Q_{max} e^{\beta(t-t_{max})} \quad \text{Eq. 6.1}$$

where $\dot{Q}(t)$ is the heat release rate, Q_{max} is the peak heat release rate, β is the fire decay coefficient, t is time, and t_{max} is the time to reach peak heat release rate. The average decay coefficient, β , varies between the values of -0.11 min⁻¹ and -0.06 min⁻¹ depending on the car category.

Y. Shintani et al [7] have burnt multiple cars and observed the trend and correlations they could take out of the experiments. They have concluded that the total burning duration is proportional to the car body weight

$$t_t = 0.035 * W \quad \text{Eq. 6.2}$$

where t_t is the total burning duration and W is the body weight of car [kg]. Therefore, for the sake of simplicity, it was decided to use this equation to determine burning duration for each car category based on weight.

The car experiments in [8] showed a better correlation between weight and total energy potential than between weight and peak heat release rate. Therefore, instead of assigning predetermined peak HRR values to different car categories, it was decided to take another approach to determining the peak HRR. The way to describe fire growth, fire decay, fire duration and the total energy released for each of the car categories

are known. The integral of the HRR curve (or area under the HRR curve) represents the energy released. This can be depicted looking at the graph on Figure 6.2:

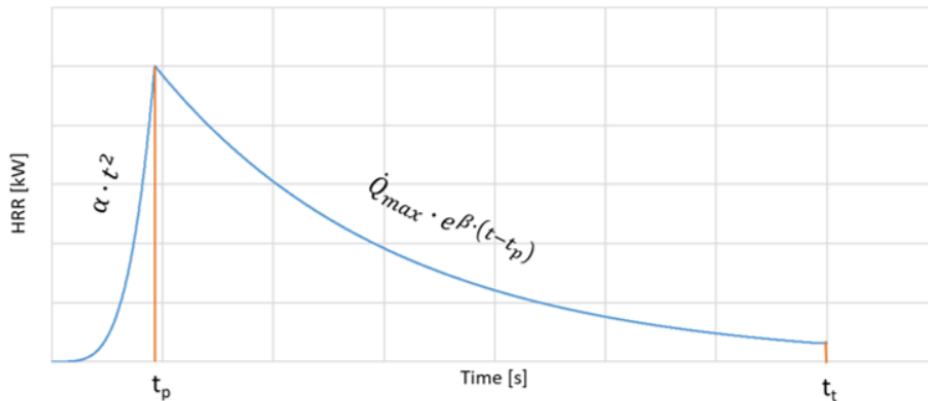

Figure 6.2: Theoretical HRR curve

Fire growth and decay coefficients α and β are predefined, and total time of burning t_t is also known. The only unknown on the presented graph is the time at which peak HRR is reached, known as t_p . With the peak HRR known, Q_{max} , the formula $Q_{max} = \alpha \cdot t_p^2$ can be used to determine t_p . As previously explained, the integral of the presented curve is equal to total heat released, which is a known number and given for each category in Table 6.1. Integrating the fire curve results in an equation with only one unknown, namely t_p . When t_p is finally known, it can be calculated as Q_{max} or Q_{peak} as $\alpha \cdot t_p^2$. Finally, the HRR curves for the 4 proposed categories take the form given in Figure 6.3.

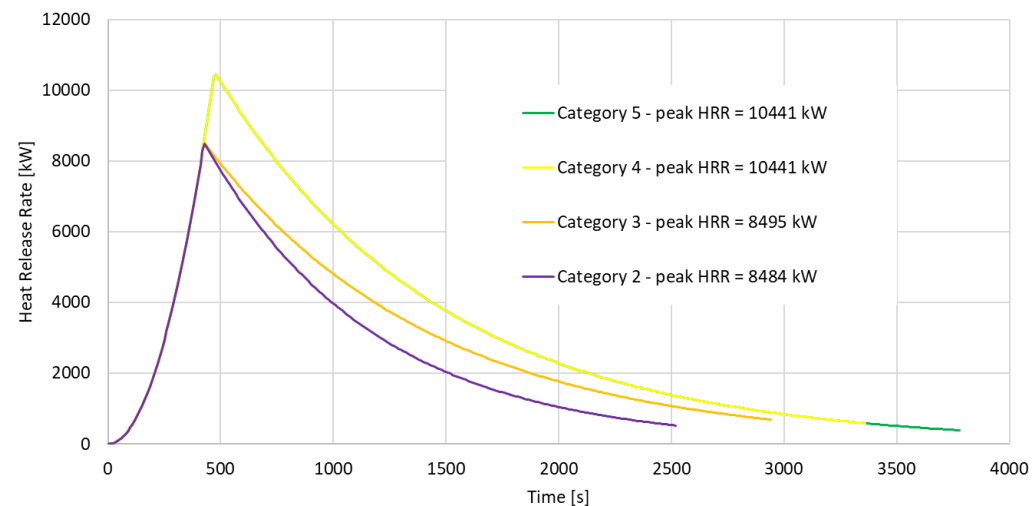

Figure 6.3: HRR curves for different car weights

It can be observed that categories 2 and 3 have similar peak HRR values, while categories 4 and 5 have the same peak HRR values. In current study the simulations were run up to 1800 seconds only, as it was enough to see the onset of tenability conditions. The high peak HRRs are in accordance with the peaks of various experimental campaigns summarized in NFPA’s report on Modern Vehicle Hazards in Parking Garage [9].

Figure 6.4 compares HRR curve for car category 4 to the latest EV test results [10] for a smaller EV (EV A) and a family EV car (EV B). Additionally, the comparison is made to a reference curve for vehicle fire proposed by Joyeux et al. [3] This reference curve was deduced from the experimental campaign, where several cars have been burnt. It is also an envelope curve for all the other HRR curves for other tested cars, so it is seen as the most extreme curve from this series of experiments. The reference curve has been widely used in vehicle fire simulation such as in Collier [11], de Feijter and Breunese [12], Jansen [13], and Baert [14]. It is important to note that the reference curve was developed in 1997, so its usefulness in modern car fires is questionable.

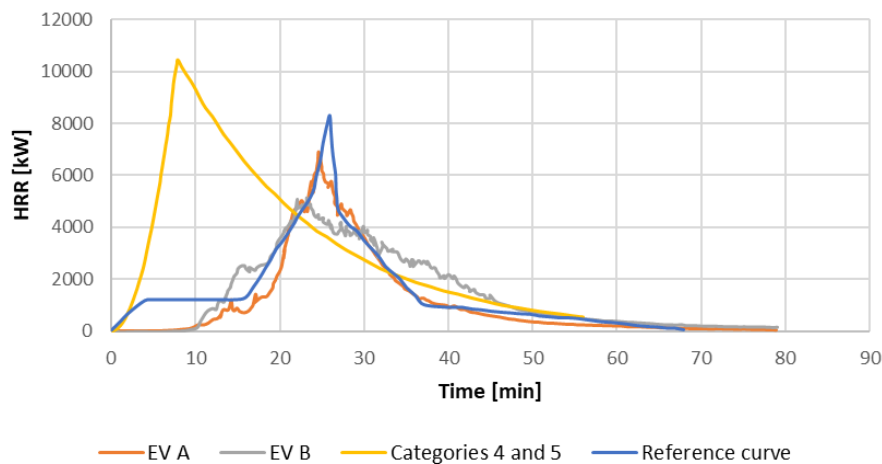

Figure 6.4: Comparison of categories 4 and 5 design curve with EV A and B and reference curve proposed by Joyeux [3]

When comparing the reference curve and EV curves to the fire curve from categories 4 and 5 adopted in this case (Figure 6.4), the fire growth in the reference curve is slower. Also, the peak HRR values for categories 4 and 5 are higher. Therefore, it can be concluded that these curves represent a more severe EV fire, as fires with faster growth and higher peaks have been observed in works done by Lecocq et al [15] and Boehmer et al [16].

For the ignition car, HRR curves from category 4 (scenarios 20_1, 40_1, 40_2, 40_3) and HRR for an EV A (scenario 40_4) were chosen. HRR of an EV A (Figure 6.4) was modified by cutting the first 6 minutes out where HRR growth in the test was nearly 0. Instead, EV A curve in the fire scenario 40_4 is set to start growing at the start of the simulation. Peak HRR for category 4 is 10441 kW, compared to 6926 kW for EV A curve.

6.4 Critical Ignition Temperature

Chapter 2.6 of the BRE report [17] gives times to ignition under different irradiance levels and determines the critical irradiance levels for the most typical materials used in cars. If convertible vehicle soft tops, and mud flaps are ignored (soft tops because they are not common in Scandinavia and mud flaps because they are not directly exposed to a fire), the next material with the lowest critical ignition temperature used in cars is rubber used for tires. The material ignited after or about the same time as the tires are the bumper according to the BRE report [17]. Bumpers are typically made of polycarbonate and acrylonitrile butadiene styrene (ABS) [18]. ABS is a very tough polymer and is also used to make Lego bricks. The following rubber tire properties have been recognized as appropriate for the simulations, see Table 6.2.

Table 6.2: Car tire properties

	Natural Rubber
Thickness [m]	0,02
Thermal conductivity [W/m K]	0,13
Specific heat capacity [kJ/(kg K)]	1,88
Density [kg/m ³]	910
Ignition temperature [C]	253

In the FDS models, 250 °C has initially been taken as the ignition temperature of rubber [19]. It is important to clarify that a simplified model of a car with only one material was made, i.e., rubber. Making a complex car model would be computationally too expensive due to the high number of cars. Nevertheless, it is assumed to be precise enough as it gave a reasonable fire spread.

6.5 Description of Fire Spread

Modelling the fire spread across the vehicle had to be simplified for several reasons. It is not practically or economically possible (too computationally expensive) to model each material involved in a car independently. Instead, the burning surface of the car is assumed to have constant properties of the rubber. Nevertheless, when modelling the fire spread using this approach the result is a uniform spread of the fire on the already ignited vehicle. This uniform spread results in fire not experiencing sudden and high peaks of HRR, which can normally be observed in car fires. In real life car fires, materials such as fuel or oil represent the source of large peaks in a rapidly developing fire. In this case it is assumed that the car has constant properties of rubber, every cell ignites only when the ignition temperature of that material is reached. The fire in this case spreads at a rate specified by the material properties of rubber and not at that of a typical car. Modelling a car with all the exact components and materials, and the fire spread between them would require more in-depth modelling, which is beyond the scope of this project.

Modelling of horizontal flame spread has its limitations and it is a current field of research. To avoid this issue and to represent the fire spread more realistically, an approach proposed by Marton [1] has been used in current simulations. In this approach, the fire spread is artificially set to the value of 0.01 m/s once the ignition temperature is reached on the surface. The fire then will spread on this surface at the specified rate and will only spread to the other surfaces (vehicles) once any point on this surface reaches its ignition temperature as well. The value of 0.01 m/s was determined after investigating several values with the aim of reaching a heat release curve closer to the desired one. This value is a satisfactory assumption regarding the fire spread in large car parks.

The adopted approach shows satisfactory values compared to the theory. In theory, the model could be improved by making a detailed model of a single car. Nevertheless, as has already been stressed, this would require way more computational time, and wouldn't bring much value to the project. This is the case with this project where fire behavior of many vehicles is of interest.

As expected, it has been observed in the model that the fire growth accelerates with time. First, after the ignition of the first car the fire grows slowly. The growth becomes more rapid as more cars are involved in fire. This is because while the fire is smaller, it takes more time before the critical ignition temperature is

reached for other vehicles. As the fire grows, the critical conditions increase and the overall heat increases resulting in critical temperature being reached by larger number of vehicles in shorter times.

6.6 Mesh Sensitivity

In the fire engineering society, there is no fixed practice to decide upon an appropriate mesh size a priori. Every CFD calculation therefore requires a mesh sensitivity analysis. However, the FDS User Guide 18 states that appropriate meshes have a high $D^*/\delta x$ -ratio, where δx is the mesh size. In this ratio, the characteristic fire diameter D^* is given by the following formula [19]

$$D^* = \left(\frac{\dot{Q}}{\rho_{\infty} c_p T_{\infty} \sqrt{g}} \right)^{\frac{2}{5}} \quad \text{Eq. 6.3}$$

Where \dot{Q} is the HRR [kW], ρ_{∞} is the ambient air density and considered to be equal to 1.2 kg/m^3 , c_p is the thermal capacity of the air and considered to be 1 kJ/kg , T_{∞} is the ambient temperature and considered to be 298.15 K , and g is gravitational constant taken as 9.81 m/s^2

6.6.1 EXPRESS 4

The calculation for deciding the optimal cell size is identical to the previous case and grid resolutions presented in Table 6.4 were chosen to perform the mesh sensitivity study.

Temperature, velocity profiles and device activation times are compared below for different grid resolutions. Figure 6.5, Figure 6.6, and Figure 6.7 below show the temperature slices in the vicinity of the ignited car at 600 s into the fire. Capturing the temperature field near the fire is essential when shifting from a single vehicle fire to multiple vehicle fires. This is due to the flame spread being modelled in FDS such that the adjacent vehicle starts igniting only after it has been heated to its ignition temperature. The heating of the surface depends on the radiation and convective heating by the gas phase.

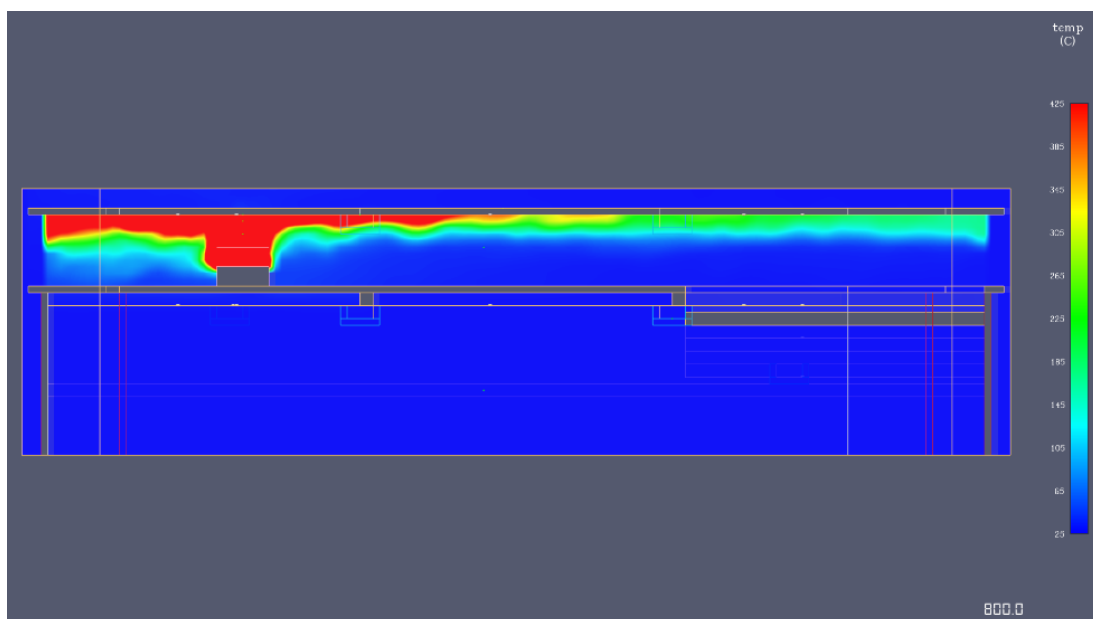

Figure 6.5: Temperature field for grid size of 20cm x 20cm x 20cm

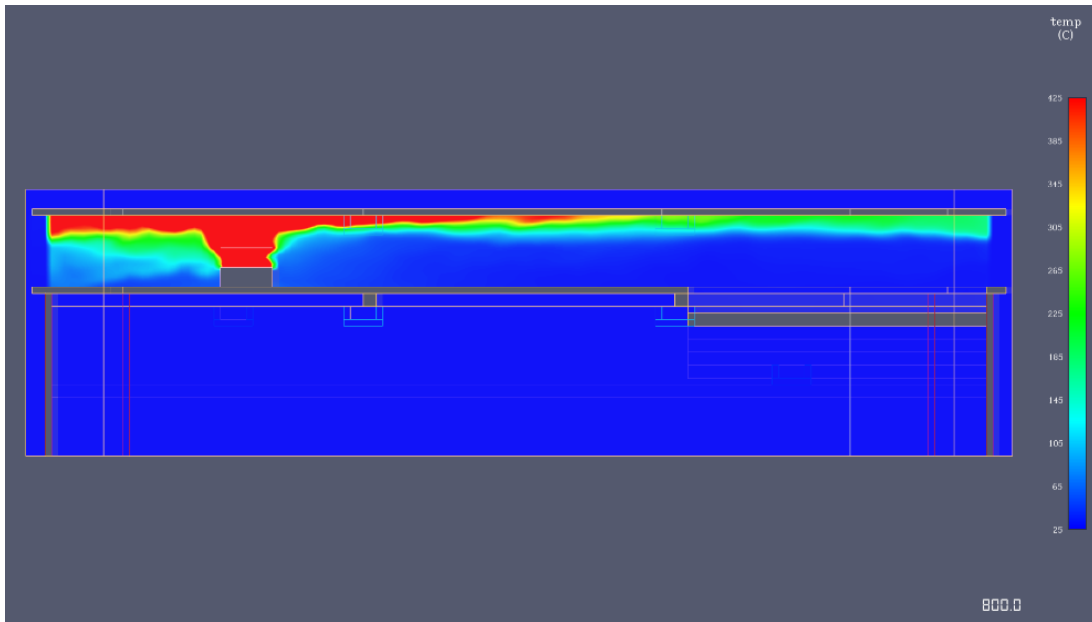

Figure 6.6: Temperature field for grid size 20cm x 20cm x 10cm

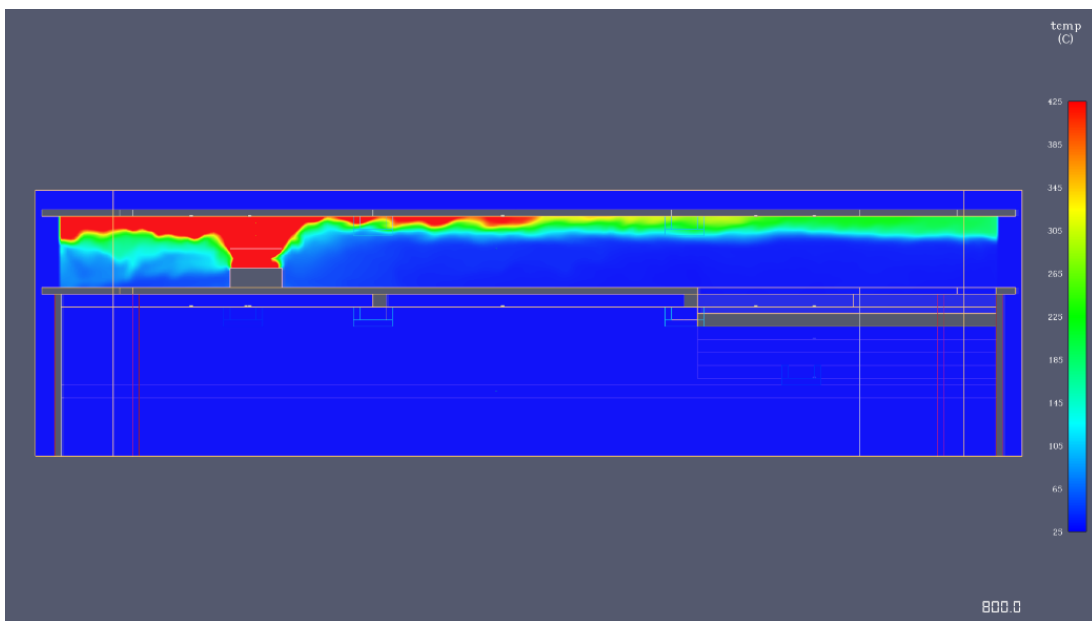

Figure 6.7: Temperature field for grid size 10cm x 10cm x 10cm

When only the temperature of the plume rising from the burning surface is considered, grid shows a wider area with high temperature, whereas the other two grids have captured a slight necking of the high temperature region just above the burning surface. However, the difference between the results from different grids shows marginal difference in the temperature predictions in this region.

The temperatures of the ceiling jet also affect the heat transfer to the adjacent surfaces. Therefore, accurate predictions of this region are essential when multiple vehicles are involved. In addition, the activation of detections systems also relies on the heat transfer and smoke dynamics within the deck. The grid resolution again seems to have a larger effect on the predictions near the burning surface. All three grid sizes show

similar temperature further away from the fire. However, near the burning surface the coarse grid with cell size has predicted higher temperatures over a larger area compared to the other two finer grid sizes. Like the plume temperature predictions, the ceiling jet predictions show only a slight difference between the grids.

Smoke transport inside the fire deck is analyzed in the below section where 3D smoke visualization has been extracted from FDS and compared for the three grids at different stages of the fire. Smoke transport is the key element for the activation of smoke detectors and visibility at the earlier stages of the fire. Figure 6.8, Figure 6.9, and Figure 6.10 show the smoke spread withing the fire deck for all three grid sizes.

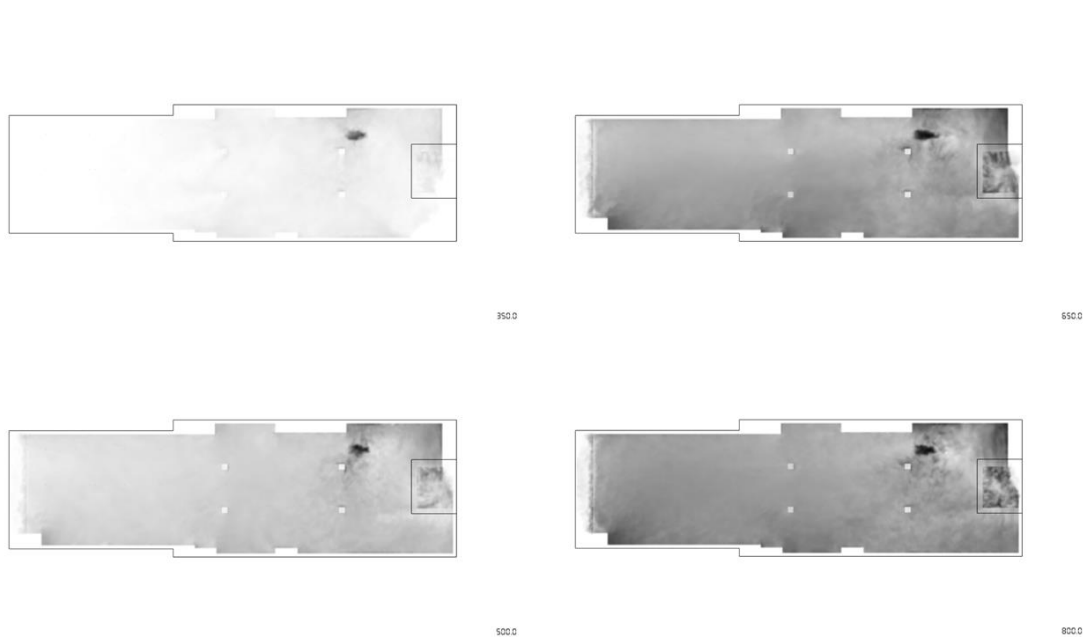

Figure 6.8: Smoke layer for 20cm x 20cm x 20cm grid at 350s, 500s, 600s and 800s

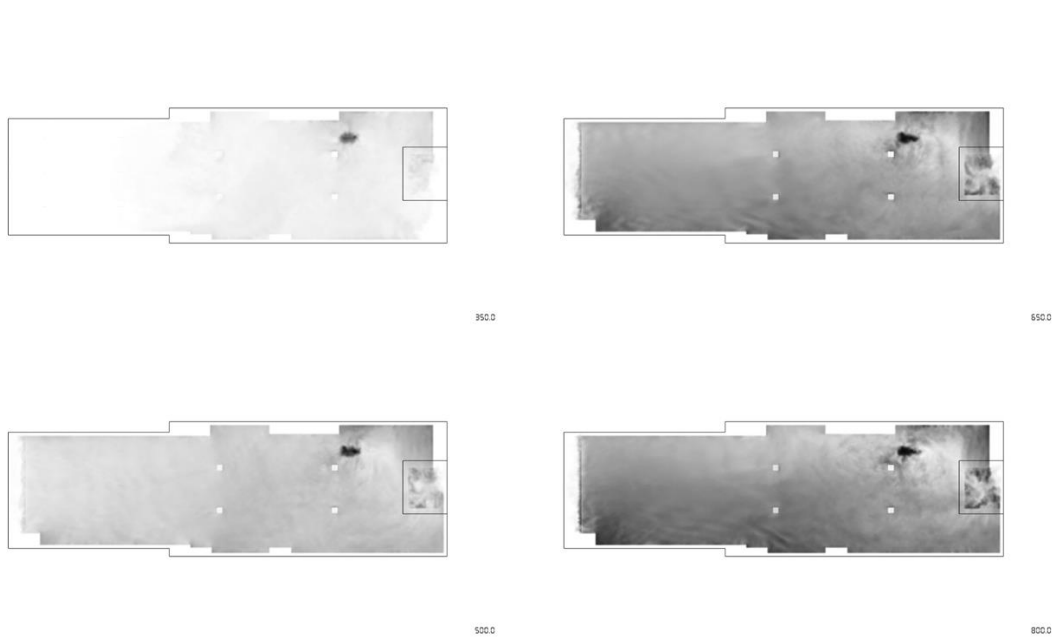

Figure 6.9: Smoke layer for 20cm x 20cm x 10cm grid at 350s, 500s, 600s and 800s

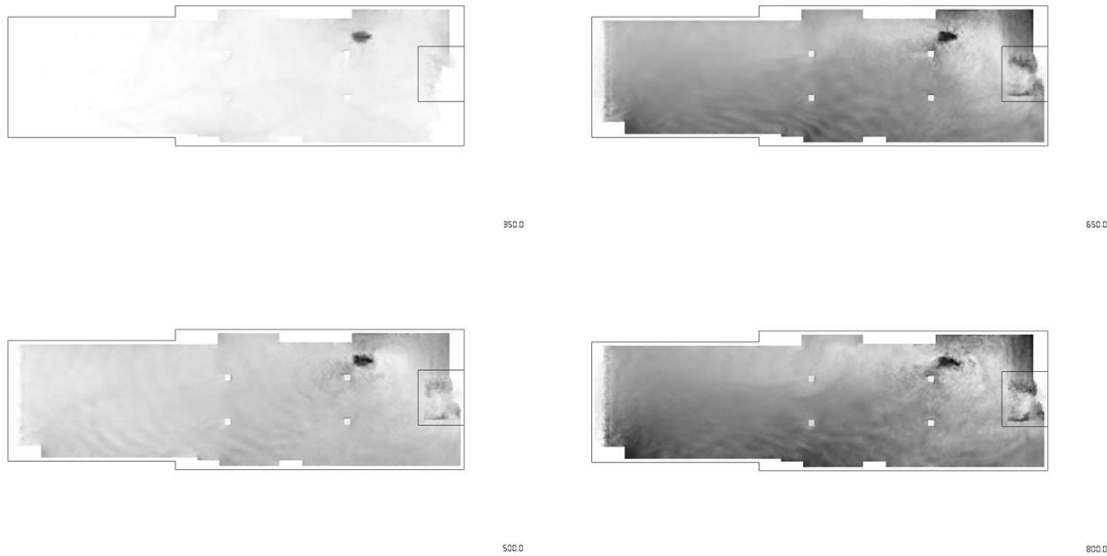

Figure 6.10: Smoke layer for 10cm x 10cm x 10cm grid at 350s, 500s, 650s and 800s

At the early stage of the fire, there is only a slight difference in the smoke spread and soot densities for all three grid sizes. However, as the fire grows with time, more smoke/ soot is produced and the predictions from the grids become more sensitive to the cell size. This is confirmed by the snaps taken from the simulations of the three grid sizes at different times. In the grid, the smoke distribution is more uniform throughout the deck while in the finer grids, less smoke is accumulated on the side of the fire compared to the regions away from the fire.

For a more precise comparison of the predictions of the different grid sizes, a quantitative analysis was performed below using data recorded by devices at different positions. Figure 6.11 shows the variation of gas phase temperature with time above the car on fire at different elevations. The temperatures were recorded using thermocouples at each point in FDS.

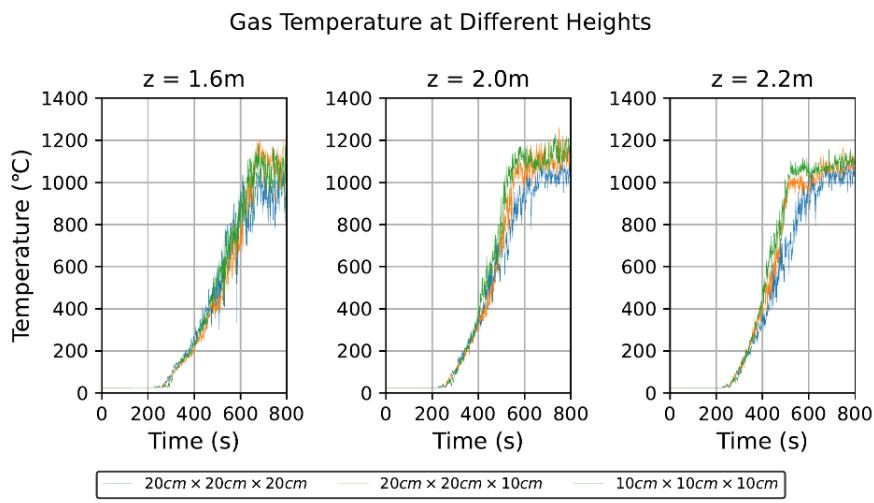

Figure 6.11: Gas temperatures at different heights for each grid resolution

The temperature predictions show a difference in the predictions from the three grid resolutions. 20×20×20 cm grid has consistently predicted lower temperatures compared to the 10×10×10 cm grid. The temperatures recorded from 20×20×10 cm grid fall in between the predictions from the other two grids, but still show great improvement compared to the coarse grid. Between 400 seconds and 600 seconds marks, recorded temperatures from the 20×20×20 cm grid shows larger deviation from the more accurate 20×20×10 cm and 10×10×10 cm grids. 20×20×10 cm grid has shown good agreement with the finer and more accurate 10×10×10 cm grid on all occasions.

Heat transfer from gas phase to the surrounding solid boundaries has been compared using the adiabatic surface temperature of a point directly above the burning surface at the ceiling level. The recorded wall temperature profile of a point on the ceiling is shown in Figure 6.12 below.

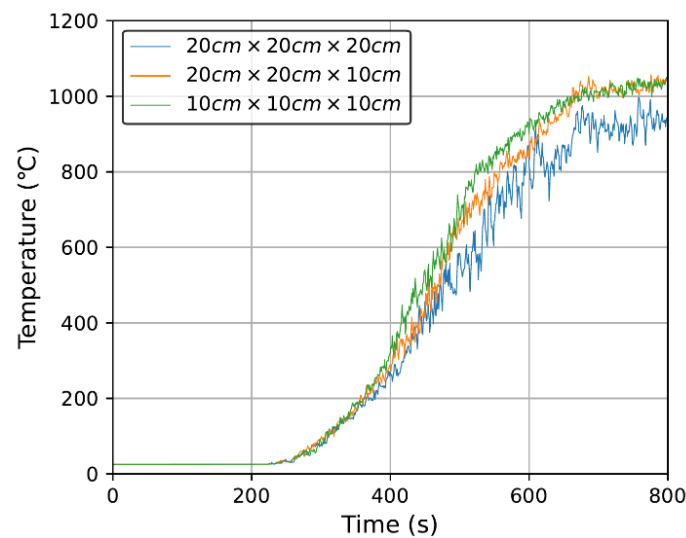

Figure 6.12: Adiabatic surface temperature at the ceiling level directly above the fire for each grid resolution

Like the predictions of the gas phase, lower temperatures have been predicted in the coarse mesh while temperatures are higher in the rest of the grid sizes with marginal difference between the two finer grids.

Detection times of the smoke detectors and heat detectors are also affected by the calculations in the gas phase. Therefore, some properties related to the detectors are analyzed in this section. During the simulations none of the detectors from tier 1 were activated, while all detectors were activated on tier 2 where the fire was placed. The same detector was activated first in all simulations and the activation time of that detector is shown in Table 6.3 below.

Table 6.3: The earliest smoke detector activation times for different grid resolution

Grid size	Activation time (s)	Activation time since the start of ignition (s)
20 x 20 x 20 cm	242.1	42.1
20 x 20 x 10 cm	246.0	46.0
10 x 10 x 10 cm	252.6	52.6

The detection times shows values within a range of approximately 10 s with the earliest detection at 42.1 s since the ignition and the latest at 52.6 second in the fire conditions. The control function for the jet fan shut down was linked with the initial detection of the fire. The two finer grids show a difference in initial detection time of only 6 s while the coarse grid shows a 10 second difference in detection to the finest grid. From the point of detection times, the three grids predict varied detection times implying a higher sensitivity of smoke distribution to the grid resolution.

By comparison of the predicted results from all three chosen grid sizes, the predictions are somewhat sensitive to the grid resolution. However, the difference between the two finer grids is not substantial as per the considered parameters. Considering this and the higher computational costs linked with the finer grids, a grid resolution of 20 x 20 x 10 cm was chosen for further analysis.

6.6.2 PEARL SEAWAYS

In all mesh sensitivity simulations for PEARL SEAWAYS fire reaches a peak HRR equal at 10411 kW, resulting in a characteristic fire diameter of 2.44 m. A uniform cubical mesh size of 0.2 m results in a $D^*/\delta x$ equal to 12.2 and for 0.1 m mesh it is equal to 24.4. The mesh size of 0.05 m results in a ratio equal to 48.8, nevertheless such simulation would take a disproportionately long time to run on the current available computer resources. These values are within the recommended limits of the FDS Validation Guide [20].

Therefore, the choice was made to test mesh starting from 20x20x20 cm. Secondly, the choice was to test a non-uniform mesh 20x20x10 cm refined in the critical for smoke movement Z direction. Thirdly, a test was made with a uniform refinement in the whole domain, 10x10x10 cm. No multiple mesh sizes were attempted due to the ventilation openings located both in the bow and in the aft of the ship. The meshes were divided into a total of 58 meshes and run in parallel. Table 6.4 shows an overview of mesh sensitivity simulations, including the total number of cells.

Table 6.4: Mesh sensitivity simulations overview including the nondimensional expression D^/dx and the total number of cells*

Mesh size [cm]	D^*/dx	Total number of cells
20x20x20	12.2	3984000
20x20x10	N/A	7968000
10x10x10	24.4	8330400

The mesh sensitivity simulations were run for a total of 780 seconds, where the first 180 seconds were run prior to the fire start to stabilize the ventilation air flow. Ventilation was set-up to 20 m³/s and was ramped down to 0 within 15 seconds, when being shut down 2 minutes after the fire started. Not all air intake openings were closed to avoid numerical instabilities in the model and because the car hold compartment is not fully airtight. A heat release rate of 10441 kW with fast growing rate was chosen to represent a burning car. Fast growing rate is characterized by a fire growth coefficient $\alpha=0.047$ kW/s² and it takes 150 seconds to reach 1055 kW. The car in the mesh sensitivity analysis was placed as shown on Figure 6.17 marked with a red rectangle.

Slices of temperature, visibility, wall temperatures, velocity, and point visibility measurements for activation of smoke detectors were made for comparison of mesh sensitivity results. For simulations with 20 cm uniform

mesh, a mesh refined to 10 cm in Z direction and 10 cm uniform mesh no large differences can be seen in all measurements. Therefore, only chosen results are shown below.

Temperature results Figure 6.13 show no large temperature differences when refining in Z direction. Figure 6.14 shows that velocities are not captured well enough with mesh of 20x20x20 cm. Same was observed when visibility results were compared for different meshes at 600 seconds for the height of 2.2 meters, see Figure 6.15. Temperature measurements over the car and obscuration measurements show similar results, Figure 6.16. Current results indicate that the mesh refined in z direction (20x20x10 cm) can be used in current simulations.

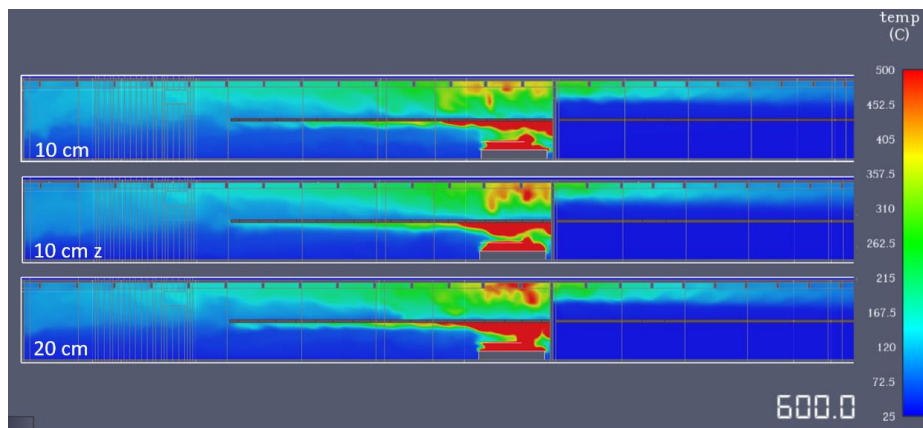

Figure 6.13: Temperatures at 600 seconds modelled with meshes 10x10x10 cm, 20x20x10 cm and 20x20x20 cm showing only minor differences. Temperature range is set to 25 C (blue) - 500 C (red). Figure shows that higher temperatures accumulate under the ramp and under the ramp and under the ceiling above the ramp.

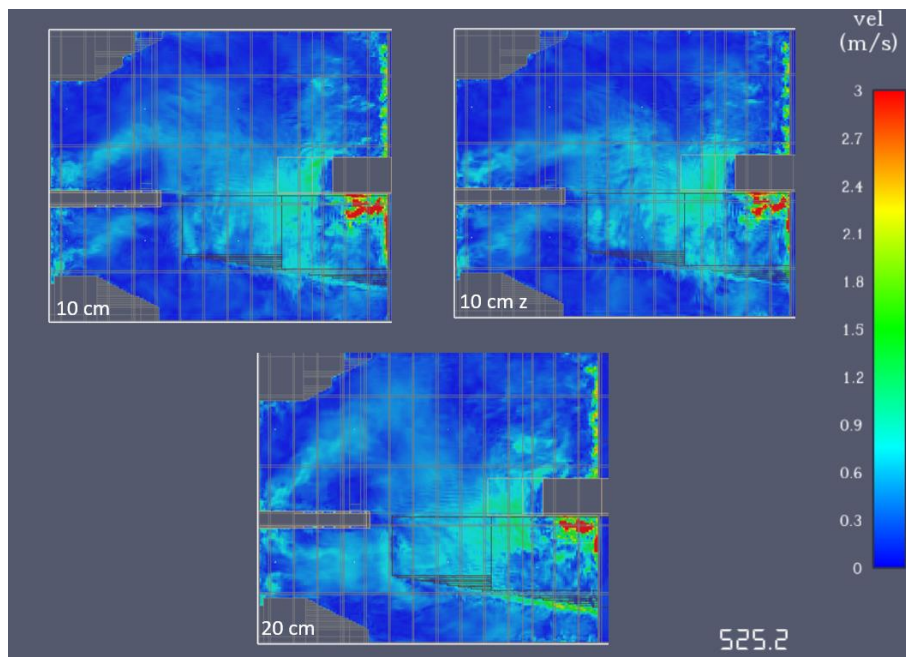

Figure 6.14: Velocities at 525.2 seconds at the height of 2.1 m for meshes 20 and 10 cm and at the height of 2.15 m for the mesh of 20x20x10 cm. Figure shows that mesh 10 cm z has no large differences from 10 cm mesh.

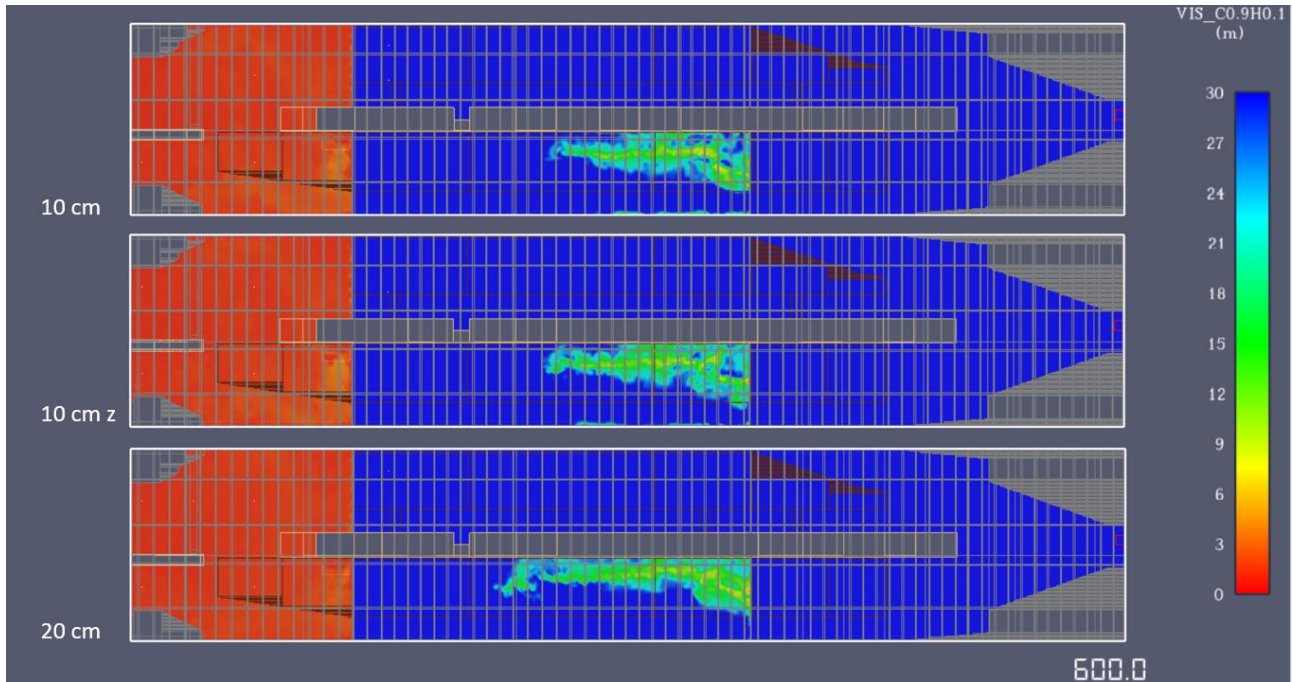

Figure 6.15: Visibility at 600 seconds for the height of 2.2 meters with 10x10x10 cm, 20x20x10 cm and 20x20x20 cm meshes. The aft of the ship where the car is burning has 0 visibility, whereas the rest of the ship behind the nearest flood door is still relatively clear at that time.

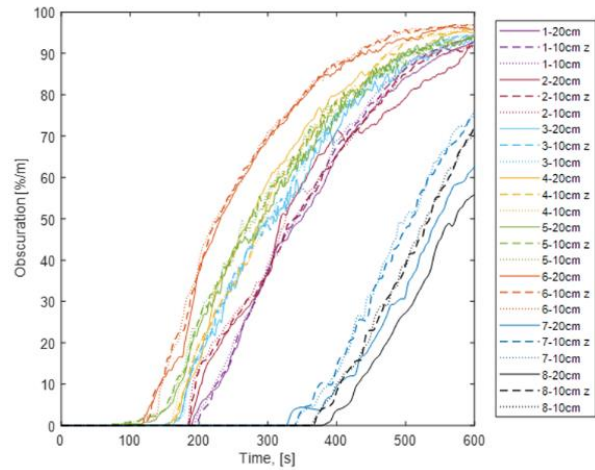
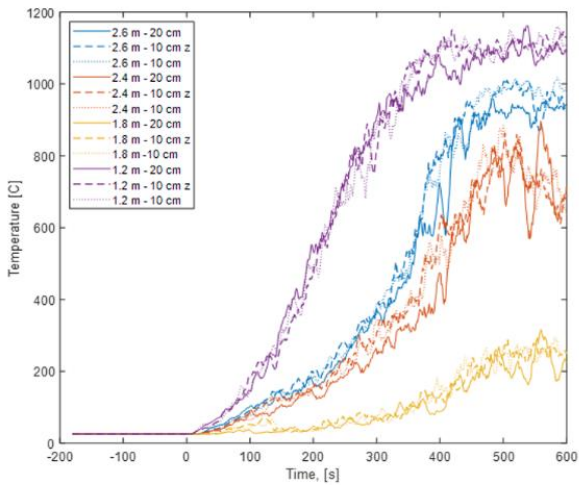

Figure 6.16: Temperatures over the car measured at different heights. 20 cm mesh is denoted with a normal line. 10 cm in z mesh is denoted with dashed line and uniform 10 cm mesh is denoted with dotted line. Obscuration results for meshes 20 cm, 10 cm in z and 10 cm for smoke detectors in positions 1-8 as shown in Figure 6.17

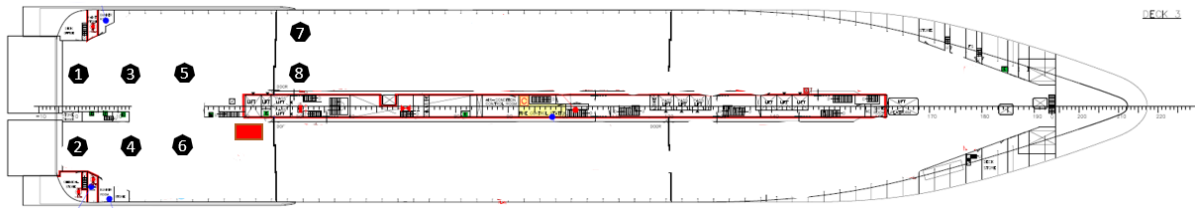

Figure 6.17: Positions of smoke detectors for mesh sensitivity analysis, marked 1-8 and a car position is marked with red rectangle

6.7 Cold Simulations

Prior to mesh sensitivity study simulations without a fire, so called “cold simulations” were performed. The aim of such simulation is to determine the time when the flow stabilizes and to detect potential recirculation zones or areas where there is no air movement (stagnation zones). In such critical areas the smoke may recirculate or build up faster.

6.7.1 EXPRESS 4

For the Molslinjen cold simulations were run to identify any stagnation zones and/or recirculation zones in both the decks. A fire in such a zone might result in higher smoke accumulation and even slower detection. It is also important from a detection point of view that the flow field inside the decks is fully stabilized with the jet fans in operation. Even though the jet fans are to be turned off after detection, during the initial stage of the fire before detection the jet fans have an impact on the smoke dynamics.

Figure 6.18 and Figure 6.19 below show velocity fields at the ceiling levels for the two decks 200 s into the simulation. The cold simulations were run for 200 s with all the jet fans turned on. Both recirculation and stagnation zones can be identified by analyzing the velocity profiles inside the decks.

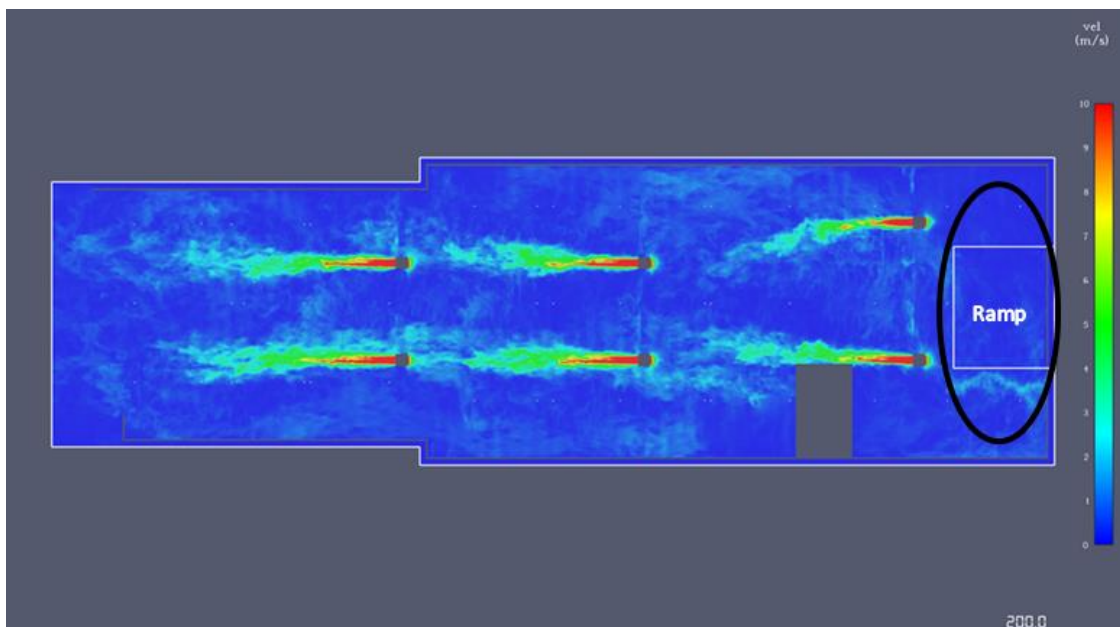

Figure 6.18: Cold simulation velocity field in Tier 1 at 200s

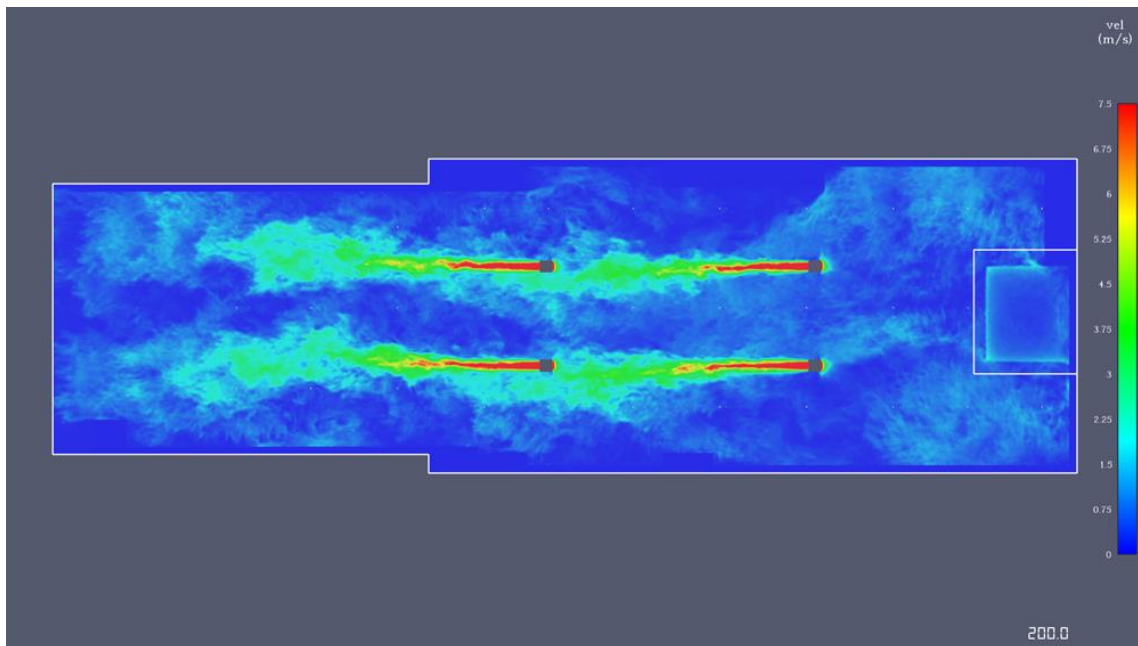

Figure 6.19: Cold simulation velocity field in Tier 2

Cold simulations showed that while the jet fans are in operation, 200 seconds is enough to achieve steady conditions inside the decks and there were no recirculation zones observed. However, in the ramp area, low velocities were recorded. This indicates that a fire starting on the ramp (Figure 6.18) could potentially lead to slower detection and smoke accumulation in the same region. Nevertheless, this area is located directly below an opening to the outside (air intake), which provides a shorter path for the smoke to the outside once the jet fans are deactivated.

6.7.2 PEARL SEAWAYS

For the duration of the transit, PEARL SEAWAYS has one exhaust fan for air extraction on with the capacity of 70000 m³/h. This fan is in the bow of the ship and corresponds to approximately 20 m³/s. There are several large air intake openings opened in the aft of the ship made according to the provided drawings. Some of the intake openings are in the center, others are located on the sides and one air intake is on the ceiling. Ventilation is on for the whole duration of the cold simulation.

First results indicated unrealistically high velocities in the aft close to the air intake, thus some changes were made to the air intake openings. Namely, the openings in the middle section were made larger than to avoid this phenomenon, and the small opening on the top was omitted, Figure 6.20. The openings on the sides of the aft are as in reality.

Results of the simulations have indicated large areas of air stagnation and recirculation zones in the aft of the ship and some zones around the flood doors, see red circle markings on Figure 6.20. The results allowed estimation of time it takes for the flow to stabilize, which was noted at approximately 180 seconds. This information is used in all consequent simulations prior to ignition of a car. Cold simulations have also helped to choose the position of the car for mesh sensitivity analysis as shown in Figure 6.20.

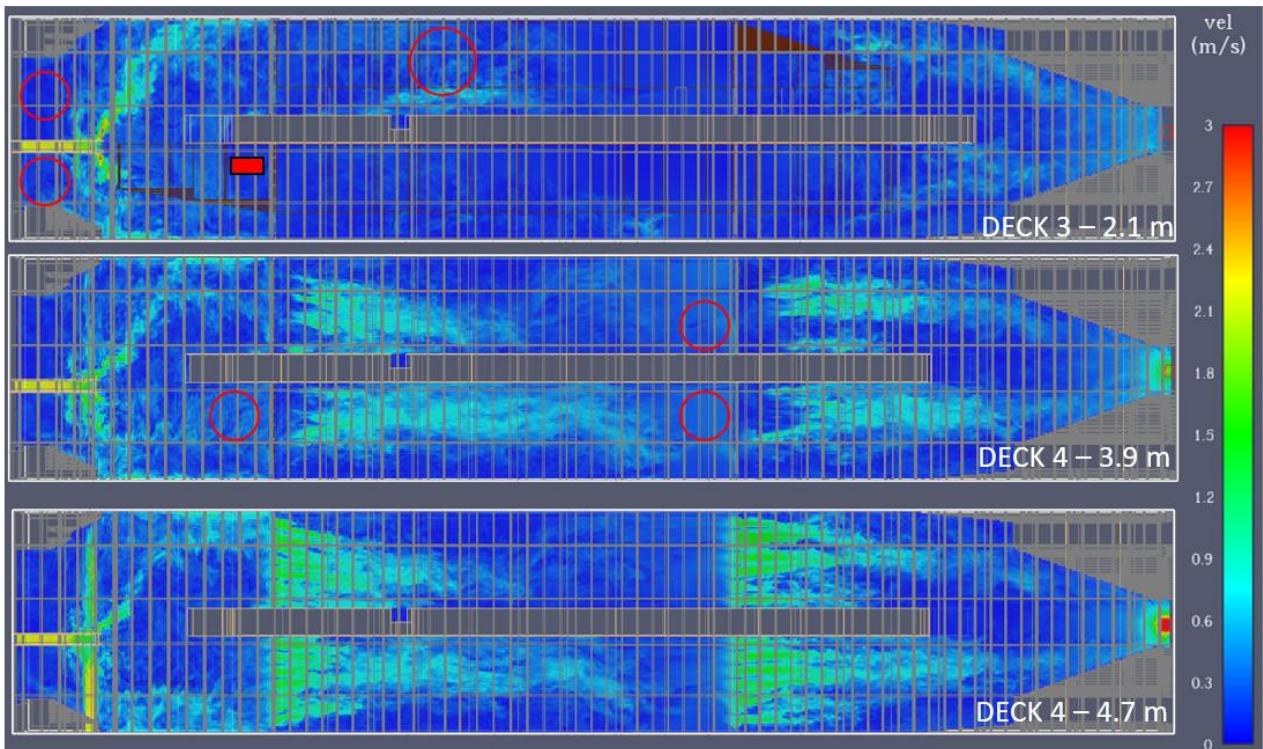

Figure 6.20: Cold simulation of air flow velocity on the deck 3 and deck 4 at the heights of 2.1, 3.9 and 4.7 meters.

The choice for car position in mesh sensitivity analysis is marked black. Some of the potential stagnation and recirculation zones are marked red and can be used as a worst-case ignition point scenario. The larger air intake in the middle of the aft is indicated with an arrow at 3.9 m. Two smaller air intakes are located at the higher level and can be seen at 4.7 m.

6.8 EXPRESS 4 Fire Simulation Details

6.8.1 Numerical Set-up

The numerical set-up is identical to the previous case (DFDS PEARL SEAWAYS), except for the geometry and materials used for the construction of the ship structure, namely aluminum, aluminum honeycomb and Lauscha B-00-F insulation material. Thermal properties of aluminum alloy (Al 5083) were used for the ship bulkhead and decks [21]. The fire insulation panels are constructed from a 6.5mm thick layer of Lauscha B-00-F and a 10 mm thick Al honeycomb panel [22]. Lauscha B-00-F is an insulation material made from glass microfibers and therefore, thermal properties of glass microfibers were used [23, 24]. The thermal properties of the respective materials used are shown below in Table 6.5.

Table 6.5: Material properties used in simulations of Molslinjen

Material	Conductivity	Density	Specific heat	Emissivity	Reference
Al 5083	117	2650	900	0.9	[21]
Al honeycomb	237	2700	900	0.9	[22]
Insulation panel	0.03	110	746	0.9	[23, 24]

The jet fans have been included in the computational model with constant flow rates and a control function to turn them all off when the fire is detected. Constant volume flow rates of 4.68 m³/s and 3.225 m³/s were used for the jet fans in tier 1 and tier 2 respectively, based on the details provided by the client.

6.8.2 Vehicle Decks (Tier 1 and Tier 2)

The ventilation requirements are fulfilled on both decks using jet fans which are installed at the ceiling levels of each deck. The opening for fresh air intake is located at the front of the ferry on the ceiling level of tier 2. This opening has an area of 73.4 m². Both decks are completely open from the back of the ferry, where the vehicles will be loaded, and these openings are the outlets for the air flow through the decks. The areas of these two openings are 139.2 m² for tier 1 and 61.5 m² for tier 2. The jet fans have the capability to supply 20 air changes per hour for both decks even though the fans only operate at a load of 10 air changes per hour during the journey. These jet fans are to be turned off manually in case of a fire on one of the decks, but during the very early stages of a fire the fans will be in operation until the fire is detected. A total of 7 jet fans are installed on the ceiling of tier 1 including a single jet fan which is installed under the ramp coming down from tier 2. Tier 2 is equipped only with 4 jet fans on its ceiling. The jet fan arrangements for the two decks are shown in Figure 6.21 for tier 1 and Figure 6.22 for tier 2.

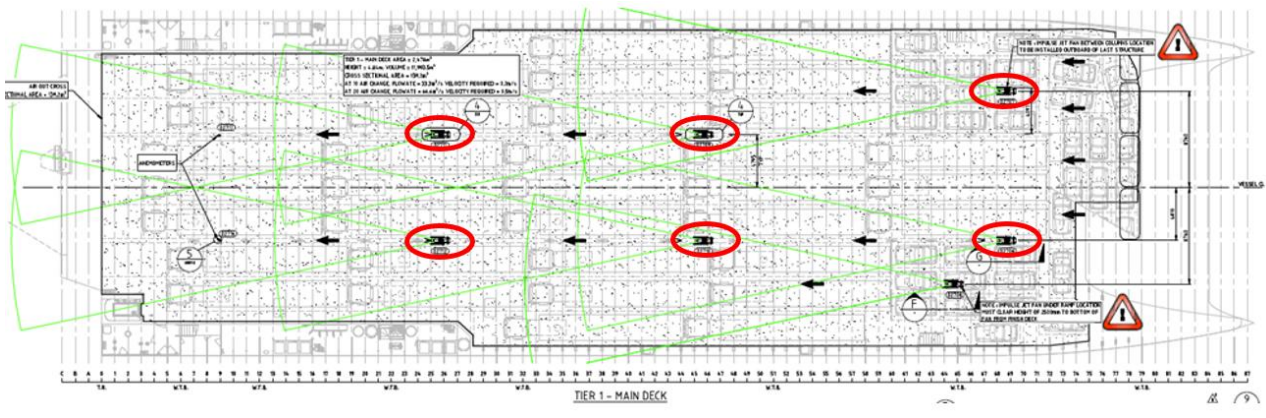

Figure 6.21: Ventilation system in tier 1 with 6 jet fans locations highlighted. The 7th jet fan is located under the ramp from tier 2 (not shown on the plan)



Figure 6.22: Ventilation system in tier 2 with jet fans locations highlighted

The structure of the ferry is made of lightweight aluminum, which has a melting point around 660 °C, a temperature which can easily be reached during a fire. Therefore, it is essential that the elements of the structure of the ferry are well insulated from the inside of the structure. The aluminum shell plates of the ship bulkhead and the beams of the ceiling of tier 2 are protected with lightweight ‘Rapid Access Composite’ (RAC) panels which are A60 fire rated. These insulation panels are installed with a large air gap between the panels, the shell plates, and the beams. It should be noted that the ceiling of tier 1 on top of which the vehicles are stowed at tier 2 is not insulated in any way from the side of tier 1. Tier 2 is not considered as a part of the superstructure of the ferry. Therefore, if tier 2 was to collapse, the structural integrity of the ferry will not be compromised.

Both decks are equipped with heat detectors, smoke detectors and flame detectors on the ceiling level. The decks also come with a drencher system installed, which is to be activated manually in case of a fire. The uninsulated aluminum floor will be flooded by this drencher system once it is activated. The fire detection layout example for the tier 1 aft is shown in Figure 6.23 below.

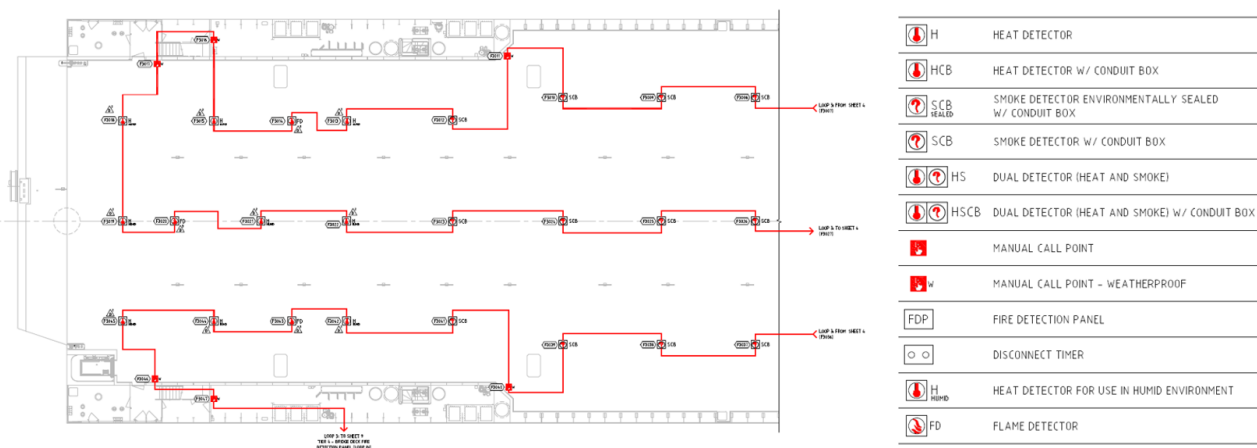

Figure 6.23: Fire detection plan for tier 1 aft

6.8.3 Car Distances and Distribution

If an EV onboard a ferry was to catch fire during the journey, it is highly likely that it will be surrounded by other vehicles at certain distances. Most often, the vehicle decks are packed rather tightly, especially during the busy seasons. The distances between stowed vehicles onboard the ferry becomes an extremely important factor during the initial stage of a fire due to the fire spread. Tight parking arrangements on vehicle decks combined with low ceilings make it very important to investigate the times taken for the flames to reach an adjacent car(s) and feed more fuel into the fire.

The crew onboard who go in to fight the fire may face extreme conditions once the fire has spread to more than just a single vehicle. The crew onboard will only react to the fire once the alarms have been triggered and even then, additional time is required to gather the crew and gear up with the firefighting kits and eventually reach the location of the fire. Due to the low ceilings, the smoke layer could obstruct the eyeline of a human. This could potentially make it rather difficult for the crew to clearly judge whether the fire has taken over more than a single vehicle before reaching the flaming region. Having to fight a fire which is being fueled by more than one vehicle can be extremely unfavorable for the crew, given that they are not professionally trained firefighters who fight fires on a regular basis as a part of training or in actual fires.

The full vehicle arrangement on Molslinjen EXPRESS 4 ferry was shown in Figure 6.22 where the cars are stowed approximately 650 mm apart from each other when the deck is fully loaded as shown in Figure 6.24 below.

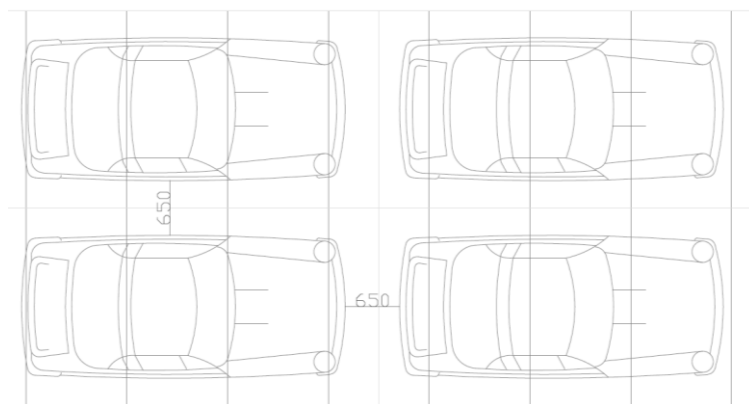

Figure 6.24: Distances between stowed vehicles in mm on Molslinjen EXPRESS 4

This distance of 650 mm can vary in real life and information from the crew from Molslinjen suggested that the distances could also go as low as 400 mm in a real-life scenario. Due to the uncertainty around the distances among cars when stowed simulations were run both with 40 cm gaps and 60 cm gaps. The distances between the vehicles are a governing factor in the initial spread of fire to the adjacent vehicles and the results of the simulations with multiple cars will focus on the flame spread properties within the deck, especially during the early stages of the fire.

The vehicle decks of Molslinjen EXPRESS 4 are designed with a nominal capacity of 425 cars when fully loaded. The number of cars which can be stowed maintaining the two different gaps vary from 454 cars (40 cm gaps) and 422 cars (60 cm gaps) respectively. The cars were categorized into 4 different categories, where each car has one of the 4 specified HRR curves. The categories for all the cars were randomly assigned to match the distribution shown in Figure 6.1. The number of cars assigned with different HRR curves for the two cases are shown below in Figure 6.25. The cars were randomly distributed on each tier and on the ramp.

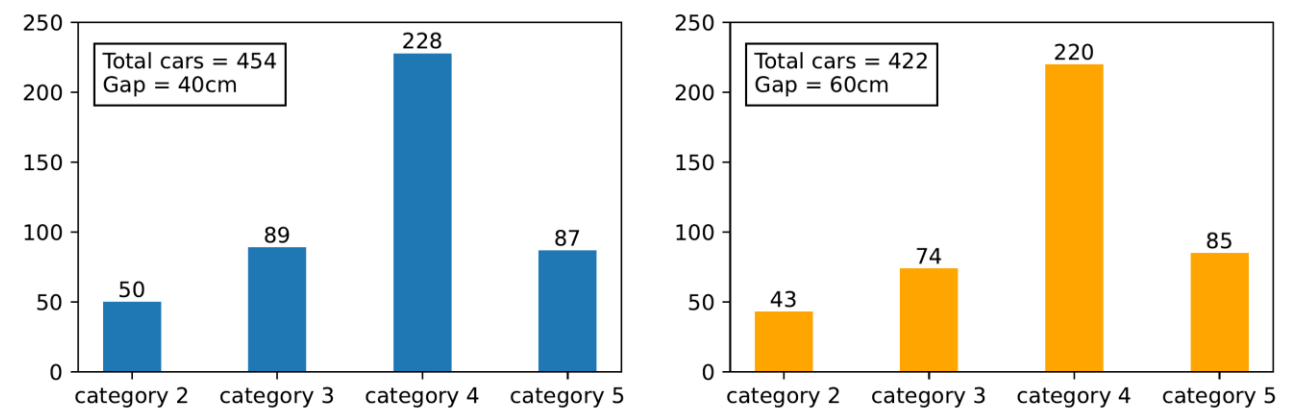

Figure 6.25: The number of cars assigned with different HRR curves for simulations with cars stowed 40 cm and 60 cm gaps

Apart from the distances between the vehicles, there are other factors which can affect the flame/fire spread to other vehicles, such as the location of the initial fire and ventilation inside the ferry or weather conditions.

The following analysis is focused on the effects of each above-mentioned parameter in a comprehensive manner.

6.8.4 Effect of Location of the Initially Ignited Car

As mentioned before, simulations were run assuming fully packed vehicle decks on both tier 1 and tier 2. Different locations were chosen based on the likelihood of having a vehicle ignited, considering the geometrical features of the decks and different ventilation conditions. The most likely location of having an EV ignited was the area surrounding the charging station on tier 1 (L1 and L2 Figure 6.26). This assumption was made due to the charging process being a known cause leading to an ignited battery falling under the category of electrical abuse.

The vehicles are stowed on three different levels on the two decks, which are the two tiers and the ramp. Each level has different ceiling heights, which affects the smoke distribution within the space and hence the radiative heat feedback from the smoke layer to the surrounding vehicles will be different in these locations. Considering that both tiers are extremely large spaces in terms of floor area, several locations have been chosen on each deck representing different zones of each deck. These locations were chosen based on the degree of access to fresh air in each location. The chosen locations are given below in Table 6.6. The chosen locations are also shown below in Figure 6.26.

Table 6.6: Initially ignited vehicles for different fire scenarios

Tier 1	Charging station – near wall	Location 1 (L1)
	Charging station – central	Location 2 (L2)
	Near air output	Location 3 (L3)
Ramp	On the ramp	Location 4 (L4)
Tier 2	Near air intake	Location 5 (L5)
	Near air output	Location 6 (L6)



Figure 6.26: Locations of the vehicles ignited first in different fire scenarios on tier 1 and tier 2 of Molslinjen EXPRESS 4

The analysis will focus on the initial detection times and time taken for the fire to spread to an adjacent vehicle. The results are given below in Table 6.7. It should be noted that all the results tabulated below are extracted from the simulation run assuming the vehicles are stowed 40 cm apart from one another which is the more representative of the real-life parking arrangement on the ferry.

Table 6.7: Detection and fire spread times for different fire locations for cars stowed at 40 cm distance

		Earliest detection time (t_d) [s]	Time taken for flame spread (t_s) [s]	$t_s - t_d$ [s]
Tier 1	Charging station – near wall	38	183	145
	Charging station – central	52	461	409
	Near air output	165	308	143
Ramp	On the ramp	54	304	250
Tier 2	Near air intake	42	278	236
	Near air output	96	272	176

Lower detection times have been recorded at tier 2, which has a lower ceiling height of 2.2 m and no beams (smooth ceiling). This reduces the smoke travel times to the detector compared to tier 1 which has a ceiling height of 4.6 m with beams. Relatively lower detection times have been recorded for fire on the ramp as well, which is due to the air flow induced by the jet fans guiding the smoke in the direction of tier 1 as shown in, Figure 6.27 which reduces the smoke travel times in that case. It should be noted that the jet fans were turned off only after a detector had been activated. Therefore, prior to activation the jet fans are working as usual continuously affecting the flow of smoke on the decks.

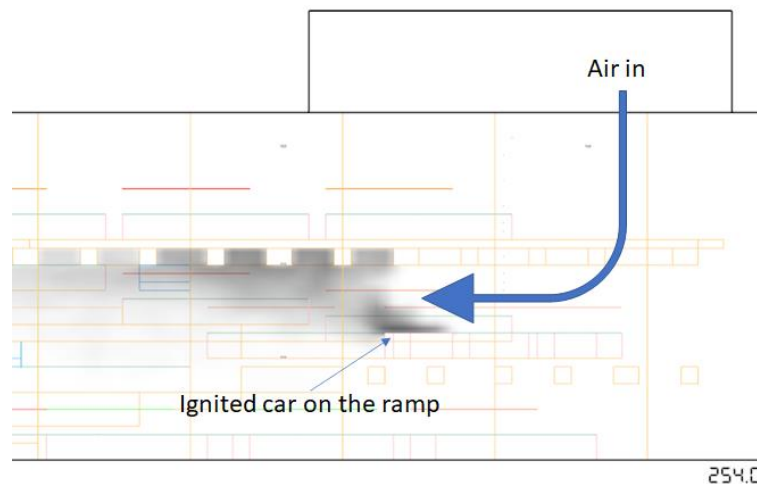

Figure 6.27: Smoke dynamics for fire at the ramp at 254 s into simulation. The air flow induced by jet fans results in relatively low detection times.

If different locations on the same deck are considered it is evident that a fire starting near the air output of the decks will take longer to detect on both decks by a considerable margin. Most of the smoke is forced out of the ferry because of the jet fans or the movement of the ferry, see Figure 6.28. When the fire is placed

away from the air output this effect disappears since the smoke will be trapped within the deck where smoke detectors are present.

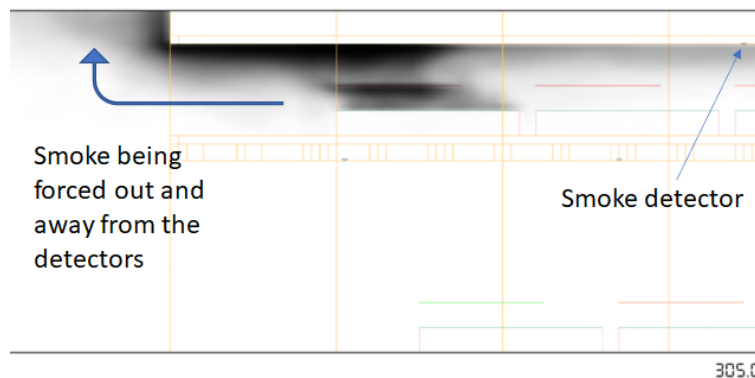

Figure 6.28: Detection time is longer when the fire starts near the air output

The smoke detectors are spread throughout the whole deck. However, the air flow through the decks due to the movement of the ferry or the jet fans could push the smoke out of the range of the detectors. This would prolong the detection times in certain locations. The scenario shown in Figure 6.28 clearly shows the effect of natural air flow pushing the smoke away from the detector. Nevertheless, in this scenario the smoke was pushed directly out of the deck which might leave a trail of smoke on the path of the ferry which can be visible from passenger decks, though this cannot be considered as alternative to a fixed smoke detector.

The time difference between the time it takes for the flame to spread and the earliest detection time ($t_s - t_d$) can be considered as the time that the crew has for preparation before the flames has spread over to another vehicle. Simulations show that near openings, and on tier 2 where the ceiling height is much lower, this time difference ranges from 2 min to 4 min while a fire in central location gives the crew around 6 min time window to gear up and fight the fire.

6.8.5 Effect of the Parking Arrangement

The parking arrangement in the vehicle decks in real life could change depending on the season and the time of the day. For this analysis two arrangements were considered where the cars were stowed with gaps of 40 cm and 60 cm. A larger gap between two cars implies the flame spread might take longer allowing for more time for the crew to muster and gear up before fighting the fire, see Table 6.8.

Table 6.8: Effects of parking arrangement for gaps of 40 and 60 cm between the vehicles

Gap		Earliest detection time (t_d) [s]		Time taken for flame spread (t_s) [s]		$t_s - t_d$ [s]	
		40cm	60cm	40cm	60cm	40cm	60cm
Tier 1	Charging station – near wall	38	38	183	274	145	236
	Charging station – central	52	55	461	506	409	450

	Near air output	165	171	308	394	143	223
Ramp	On the ramp	54	70	304	310	250	240
Tier 2	Near air intake	42	44	278	305	236	261
	Near air output	96	128	272	300	176	172

Increasing the gap among cars by 20 cm has resulted in longer times taken until the flames have spread over to an adjacent car. Depending on the location, the flame spread has been delayed by a few seconds up to almost 2 min. These increments have resulted in higher gaps between the initial alarm and the point when the flames spread to the second car. This allows a larger time interval for the crew to get ready to fight a fire before the fire has consumed more than a single car. The detection times have not been affected as much as expected because the initial fire was placed in the same region.

6.8.6 Effect of Ventilation (Wind/Movement of the Ferry)

As discussed in the scenarios above, the air flow inside the deck played a key role in the initial stages of the fire with respect to detection times. The usual procedure is to have the jet fans shut down during the journey of the ferry on the two vehicle decks. Nevertheless, the relative movement of the ferry with respect to the atmosphere and the openings on either side of the decks create a pathway for air flow across decks while the ferry is moving. This induced air flow will affect the movement of the smoke by pushing the smoke from the direction of air take towards the air output on the decks.

Due to the smoke being pushed towards the air output of the decks, a region on the opposite side of the ferry may be created with much less severe conditions in the earlier stages of the fire. This can be used to the advantage of the firefighting crew, when entering the fire scene. Keeping the jet fans on during the fire can also be considered as like the moving ferry case. To analyze the effect of these two scenarios, simulations were run without the control function activated on the jet fans. The focus of these simulations will be primarily to see the differences of smoke movement after the alarms have been activated.

The first scenario considered in this section is a fire on tier 2 at the location L5, Figure 6.26. This location is closer to the air intake through which fresh air is constantly drawn in to feed the fire. Assuming the firefighting crew will reach fire after 10 min into the fire, the conditions at that point will be analyzed to see the effect of ventilation on moving the smoke away towards the air output from the fire seat. The visibility inside the deck at 1.6 m height from the floor level of tier 2 is shown in Figure 6.29 for the same fire with and without jet fans turned on.

The orange triangle in Figure 6.29 shows the location of the fire, and the case where the jet fans were kept turned on there is a clear difference in the visibility levels around the fire. For a firefighting crew without professional level training, this increased visibility can be extremely helpful to both locate and reach the fire seat. As expected, a ‘pathway’ with relatively better visibility to the fire seat can be created with just controlling how the smoke is handled within the deck. This idea is currently being used effectively in underground care parks in Belgium. Even though the Belgian standard (NBN S 21-208-2:2014) couples the

use of jet fans with smoke screens to enhance the effects of jet fans, in the simulations for this case, it is still clear that the jet fans or the movement of the ferry could aid the firefighting crew in such a scenario. However, the crew when trying to locate the fire, should enter the fire scene from the deck below where the conditions are supposed to be under control and reach the fire via the ramp. Directly entering the scene from tier 2 could present the crew with more challenging conditions, further complicating the situation. It is important that the smoke dynamics are well understood by the crew which can help them to use the knowledge to their advantage in such a scenario.

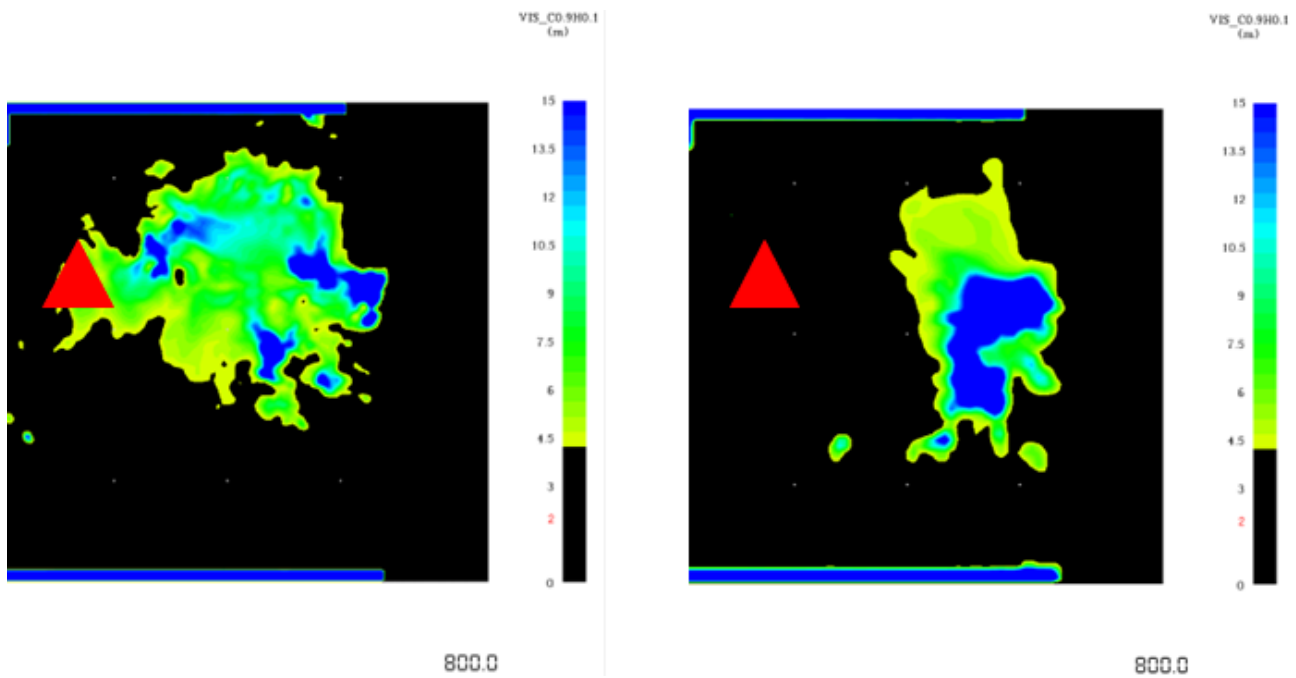

Figure 6.29: Visibility at 1.6 m of tier 2 at 800 s. Above jet fans off and below jet fans on

A fire below tier 2 implies that the buoyant smoke will eventually reach tier 2 and most of the fresh air is going to be fed via the air output opening rather than the air intake which lies above tier 2. In these cases, the effect of the jet fans on tier 1 could be less efficient due to this reason. Simulations were run with jet fans turned on for a fire on the ramp to confirm the explained case. The analysis will consider the visibility around the fire scene at a height of 1.6 m from the floor level of the ramp, and the visibility slices at 800 s into the fire are shown in Figure 6.30.

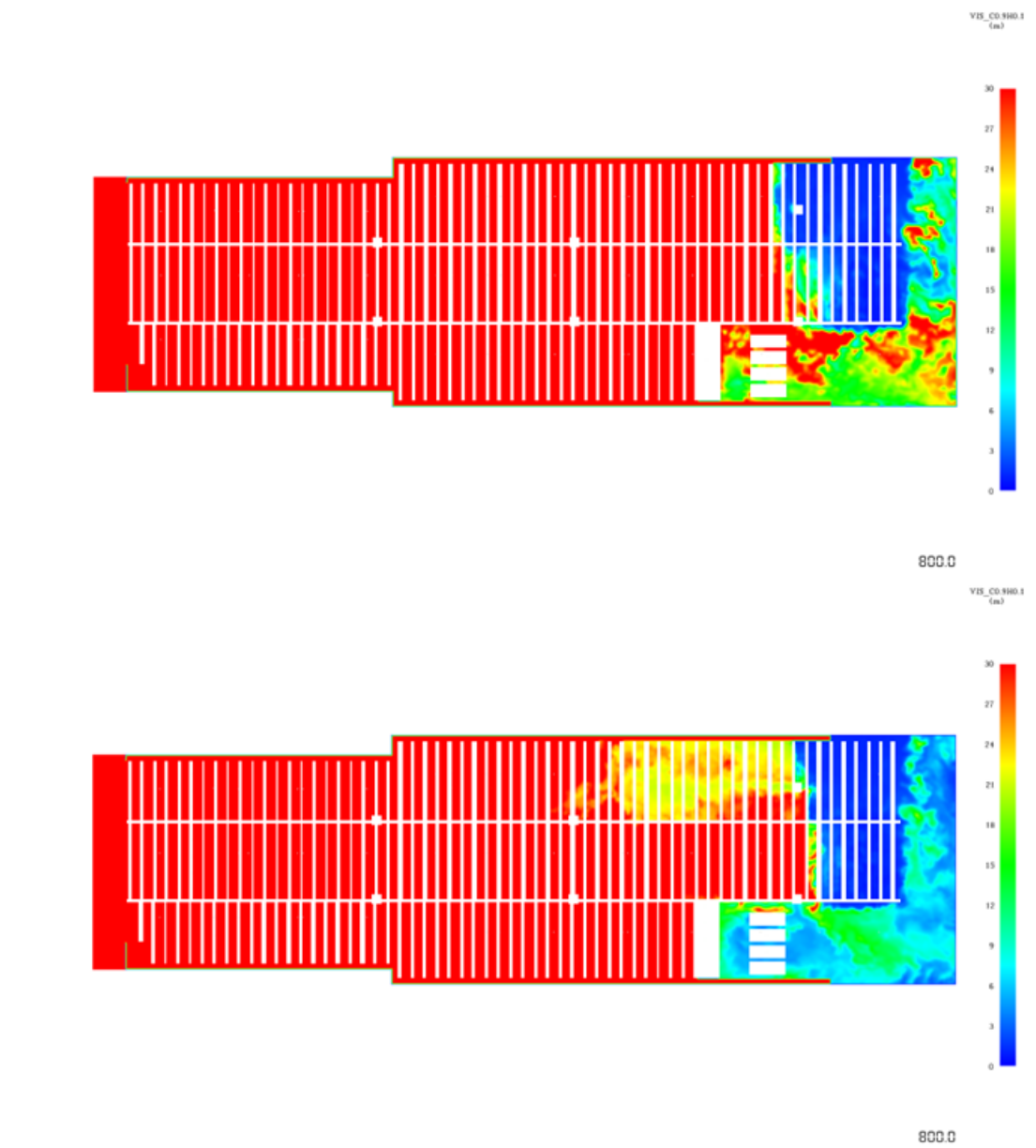

Figure 6.30: Visibility at 1.6 m from the ramp at 800 s. Above jet fans off and below jet fans on

In this scenario, even without the jet fans, there is a pathway for the firefighting crew to reach the fire seat from tier 1 via the ramp. The activation of the jet fans has caused the smoke to spread over this region making the conditions less favorable for the firefighting crew. A fire on the ramp can be considered as a tough location due to the lower overhead clearance on the ramp compared to tier 1 which has a much higher overhead clearance but, fresh air entrained from the direction of the air output pushes the smoke plume in a favorable direction creating a less severe path for the fire crew without any help from the jet fans.

6.8.7 Effects on the Structure

Aluminum has a melting point of 660 °C and the thermal stability of aluminum is much lower compared to many alloys and other metals. Czerwinski F. [25] has compared the loss of strength in aluminum against other alloys, such as stainless steel and the maximum service temperatures of aluminum is around 200 °C with a

strength of 50 MPa to 300 MPa. It has also been mentioned in the same article that the loss of strength is irreversible implying that cooling down the structure will not bring back the same capabilities of the aluminum structure.

Molslinjen EXPRESS 4 consists of two vehicle decks and the decks contain insulation layers to protect the aluminum shell plates from a fire inside the decks. However, the insulation plates are not installed in the area where the ramp is. As per the regulations [26], thermal insulation is required only covering the passenger decks and areas where passengers are expected to be present. Due to this reason the shell plate is exposed to the interior of the decks where the two decks are connected via the ramp. This implies that the aluminum shell plate on that side will be fully exposed to a fire on the ramp.

The two tiers are also made from aluminum decks, floors and the ceiling of tier 1 which is the floor of tier 2 is not insulated exposing the whole structure which is bearing the load of the cars stowed on tier 2. This ceiling lies 4.6 m above the floor level of tier 1, however, at a certain point the constant exposure to a fire below is expected to heat up the ceiling locally above its service temperature. This could lead to catastrophic failure of tier 2, the mezzanine deck. It should be noted that the mezzanine deck is not considered as part of the main superstructure and a failure of this deck will not lead to a failure of the whole structure.

The temperatures of the exposed regions were calculated in FDS and will be used in the upcoming analysis. The first scenario considered is the fire on the ramp. The wall temperatures of the exposed side of the aluminum shell plate were monitored in the simulations and the time taken for a hotspot of 210 °C – 230 °C is shown below in Figure 6.31 below. The time taken to achieve this hotspot can be considered as the onset for the thermal failure of the aluminum shell plate. It should be noted that a detailed structural analysis is required to properly assess the failure times and modes, and this is just an indication of the available time before the structure reaches undesirable temperatures.

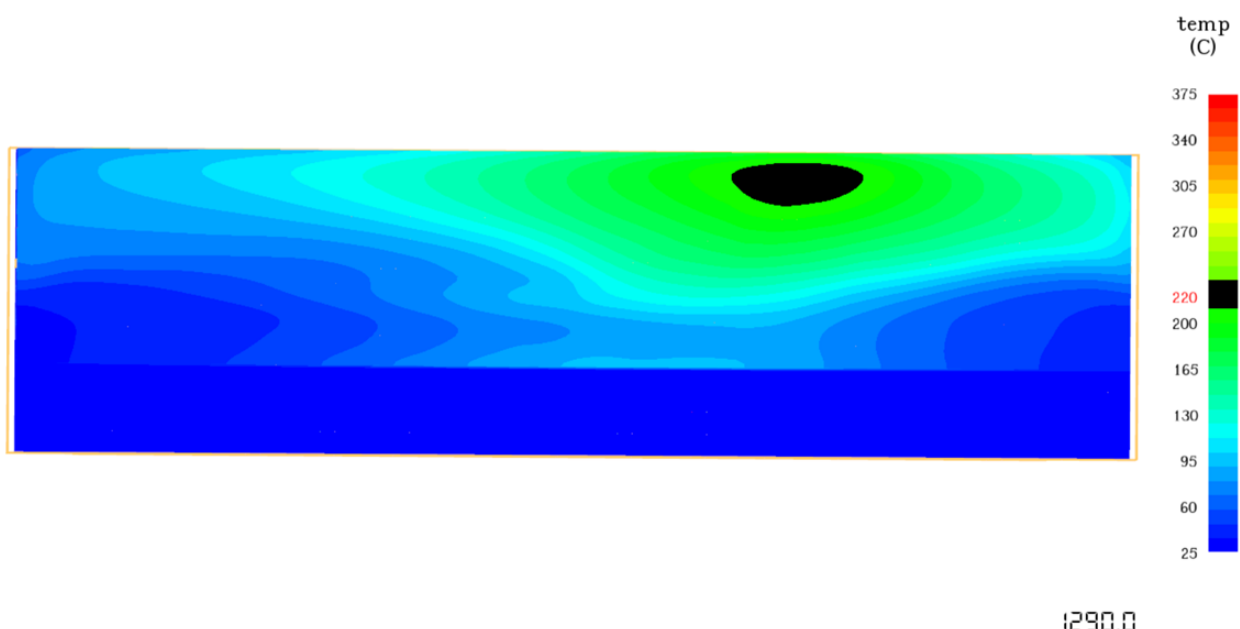

Figure 6.31: Fire on the ramp: the hot spot of 210-230 °C as an onset of thermal failure of aluminum shell plate at 20 min

As per the simulations, it takes around 20 min before the exposed sides of the aluminum shell plates reach critical temperatures. The scenario considered in the simulations does not account for the effects of firefighting and the activation of the sprinkler system (drenchers) on the vehicle deck, which could potentially stop the aluminum shell plates reaching such temperatures in the first place.

In the same scenario, the temperature of the ceiling of tier 1 which extends up to a certain distance above the ramp was also monitored. The highest recorded temperatures are expected to be above the area where the initial fire is placed. The temperature reading was just above the initially ignited car but on the ceiling of tier 1. The temperature evolution of the ceiling with time is shown below in Figure 6.32. The clearance between the ramp and the ceiling is measured at 1.8 m in the FDS geometry.

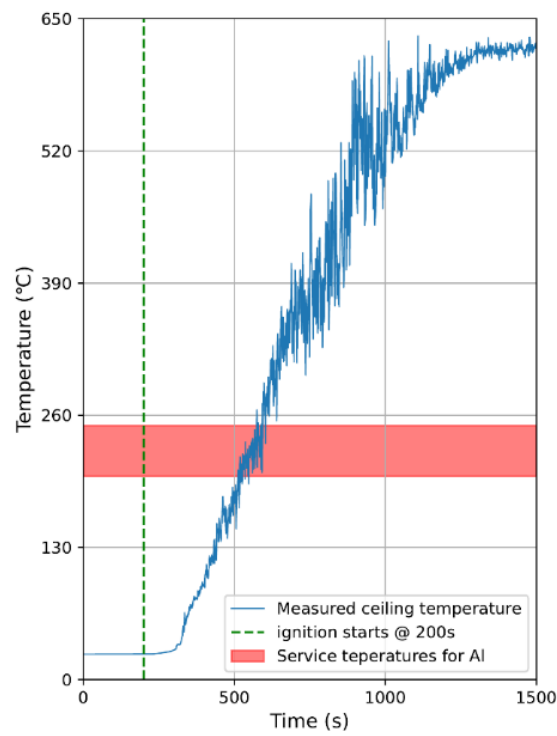

Figure 6.32: Temperature evolution of the ceiling at 1.8 m above the fire reaching critical temperature at about 300 s

The temperature evolution of the measured point on the ceiling shows increasing temperatures around 100s into the fire and around 300 s into the fire the temperatures reach the 200 °C mark which is considered as the point after which aluminum loses its load bearing capacity in an irreversible manner. It is evident that the exposed region of the structure reaches critical temperature around 5 min into the fire (fire of category 4, Car category, shown in Table 6.1, is based on the weight mass range.) and will potentially lose load bearing capacity leading to structural failure.

As the second scenario, a fire placed centrally on tier 1 is considered. The fire is in location L2 (Figure 6.26) near the charging station. Any fire in tier 1 will result in the uninsulated ceiling being exposed to the fire directly below it. The ceiling lies 4.6 m above the floor level which is relatively high compared to the scenario discussed previously. Nevertheless, a fire near the charging station can be more probable compared to the scenario above. The temperature of the ceiling was measured in FDS and the temperature profile of the ceiling 1500 s into the fire is shown below in Figure 6.33.

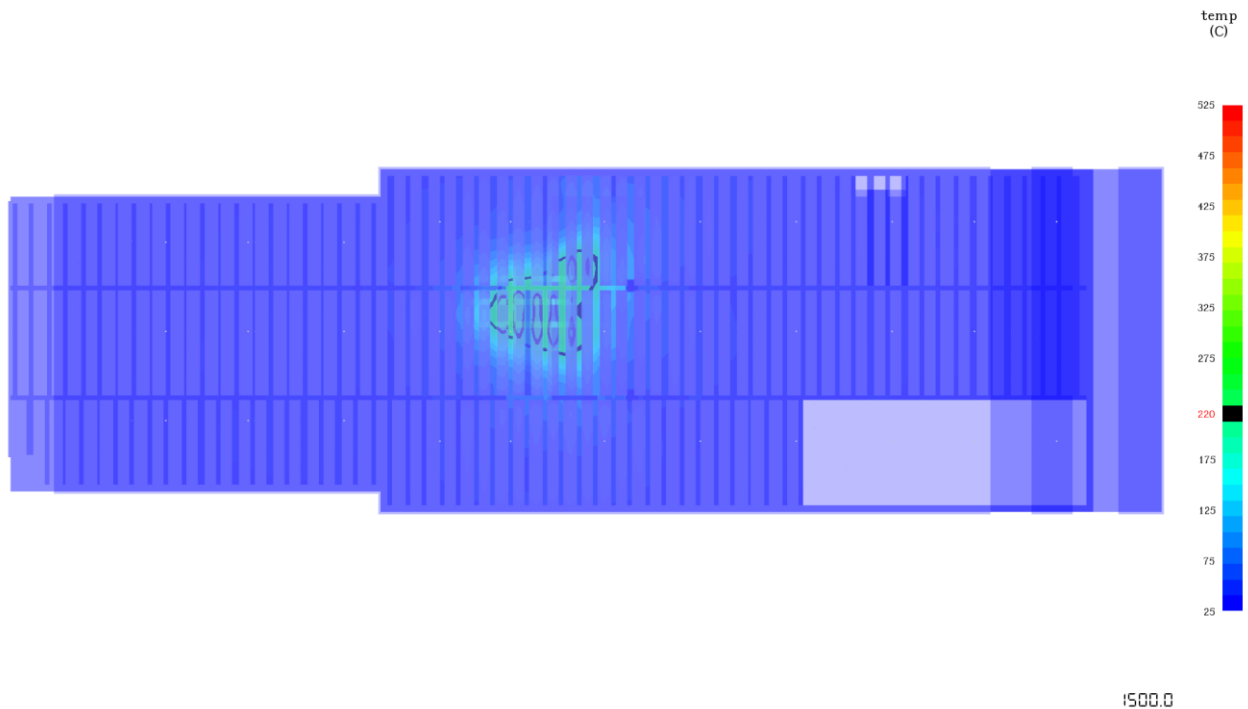

Figure 6.33: Fire on the ramp: the hot spot of 210-230 °C as an onset of thermal failure of aluminum shell plate at 20 min

As per the simulations it takes around 20 min before the exposed sides of the aluminum shell plates reach critical temperatures. The scenario considered in the simulations does not account for the effects of firefighting and the activation of the sprinkler system (drenchers) on the vehicle deck, which could potentially stop the aluminum shell plates reaching such temperatures in the first place.

In the same scenario, the temperature of the ceiling of tier 1 which extends up to a certain distance above the ramp was also monitored. The highest temperatures are expected to be recorded above the area where the initial fire is placed. The temperature was just above the initially ignited car but on the ceiling of tier 1 was monitored and the temperature evolution of the ceiling with time is shown below in Figure 6.34. The clearance between the ramp and the ceiling is measured at 1.8 m in the FDS geometry.

The scenarios modeled did not have the sprinkler system (drenchers) on the vehicle deck activated, which is otherwise the normal operating emergency response procedure onboard. This condition was chosen to examine the ‘worst case’ fires scenarios without any firefighting response taken, modeling how smoke and flame spread, and temperature rises.

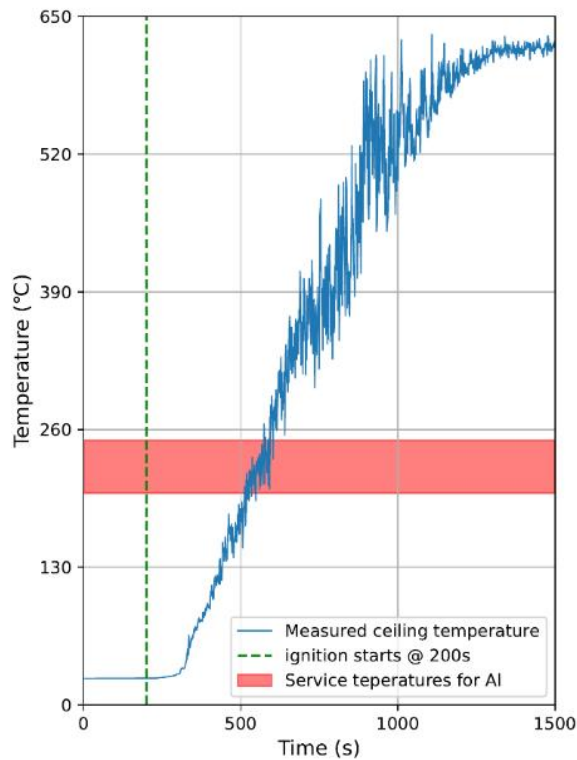

Figure 6.34: Temperature evolution of the ceiling at 1.8 m above the fire reaching critical temperature at about 300 s

The temperature evolution of the measured point on the ceiling shows increasing temperatures around 100s into the fire and around 300 s into the fire the temperatures reach the 200 °C mark which is considered as the point after which aluminum loses its load bearing capacity in an irreversible manner. It is evident that the exposed region of the structure reaches critical temperature around 5 min into the fire (fire of category 4, Car category, shown in Table 6.1, is based on the weight mass range.) and will potentially lose load bearing capacity leading to structural failure.

As the second scenario, a fire located centrally on tier 1 is considered. The fire is in location L2 Figure 27 near the charging station. Any fire in tier 1 will result in the uninsulated ceiling being exposed to the fire directly below it. The ceiling lies 4.6 m above the floor level which is relatively high compared to the scenario discussed previously. Nevertheless, a fire near the charging station can be more probable compared to the scenario above. The temperature of the ceiling was measured in FDS and the temperature profile of the ceiling 1500 s into the fire is shown below in Figure 6.35.

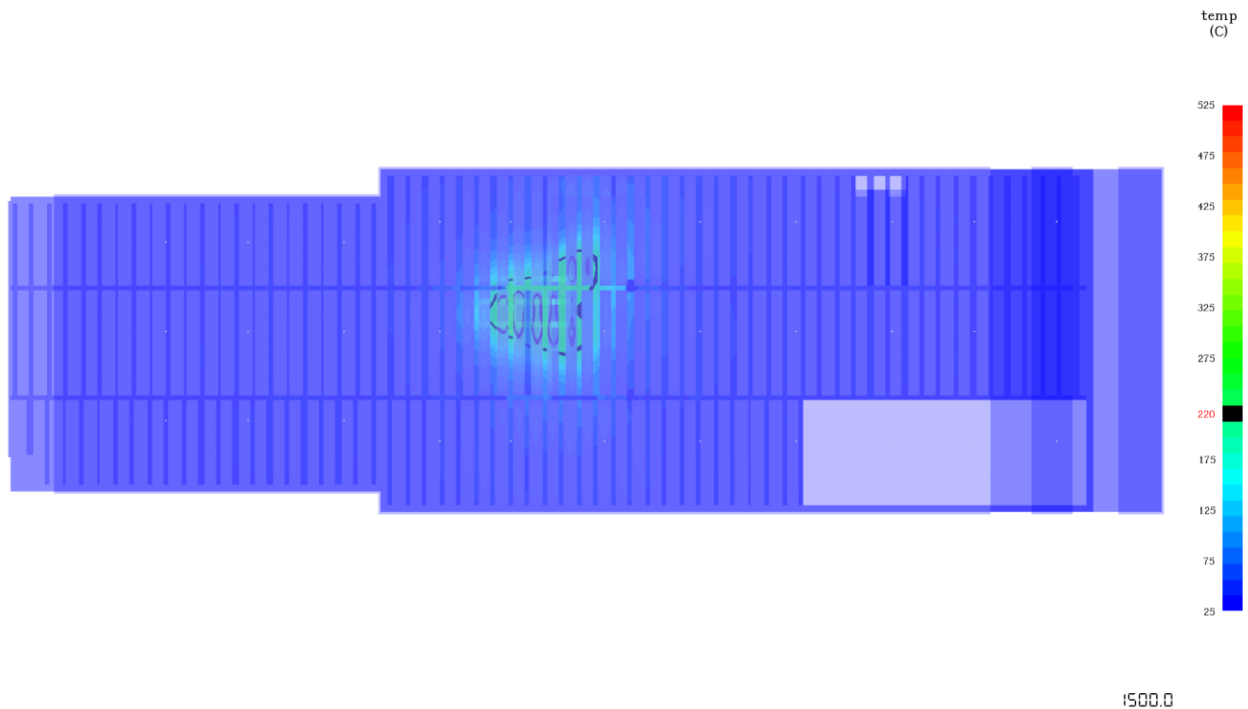

Figure 6.35: Temperature of the ceiling at 1500 s for a fire near the charging station. The beams above the fire reached critical temperatures.

The temperature of the beams and the ceiling reached above 200 °C, which is not safe operating temperatures for load bearing aluminum elements. The hotspots appear around 18 min into the fire, by which time it can be assumed that the crew has already started fighting the fire making the conditions less severe than this. Direct cooling of the aluminum structure could also help bring the temperatures down in the affected area. However, if the fire is allowed to grow without intervention from the crew, it can lead to a structural failure in mezzanine deck which could lead to more complications and extreme property damage.

6.9 PEARL SEAWAYS Fire Simulation Details

MS PEARL SEAWAYS is a DNV-GL class ship initially built in 1989 for Viking Lines and later refurbished into a car-passenger ferry for DFDS. It currently operates between Copenhagen and Oslo with a stop in Frederikshavn. In 2010 the ship experienced a fire in EV left charging onboard located in the aft on the port side that spread to the neighboring vehicles [27]. After the fire the ship was refit and given its current name. The car space consists of two decks (deck 3 and 4), where deck 4 is a ramp, Figure 6.36 shows a 3D scan of deck 3 with flood doors opened.

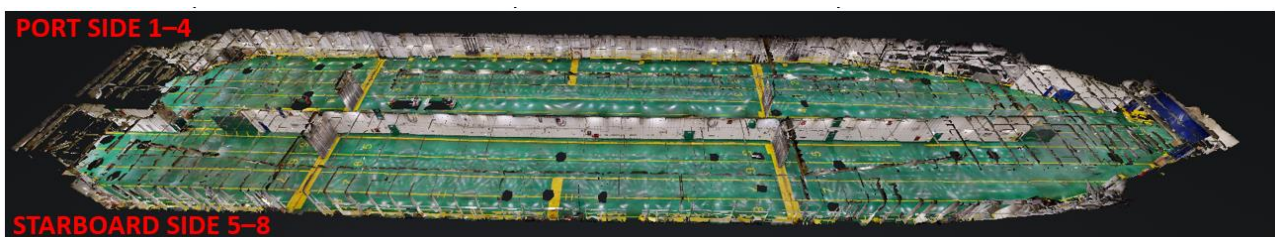

Figure 6.36: 3D scan of the PEARL SEAWAYS deck 3 without the ramp. The cars can be filled either from a starboard side into lanes 6-8 or from the port side into lanes 1-4. Lane 5 is an additional lane located between lanes 4 and 6 in the middle of the aft.

6.9.1 Car's Placement

After the mesh sensitivity analysis and flow simulations, simulation with multiple cars filling both deck 3 and deck 4 was performed. This is not a fully realistic scenario, as there are always some types of heavy vehicles present onboard, often placed in lanes 1 and 8 closer to the aft of the ship, see Figure 6.36. On the other hand, the ship will not always be fully filled with vehicles. There are cases when only deck 3 is used.

PEARL SEAWAYS currently loads the cars in two ports when departing to Oslo, in Copenhagen and in Frederikshavn. The loading order differs depending on the car deck officer's decision: the ship can be loaded either on port or on starboard side. In the model presented below it is assumed that in Copenhagen the ship is loaded from the port side, see Figure 6.36, using lanes 1-4.

Figure 6.37 shows how the cars were placed in the models and an example of ignition location for scenario 20_1. The ignition source used was a car with category 4 fire, as described in section 6.2. The rest of the cars got one of the category fires randomly assigned using the distribution shown in Figure 6.1 and a custom-made python code. The number of radiation angles was chosen to 300, with angle increment of 6 and time step increment of 6.

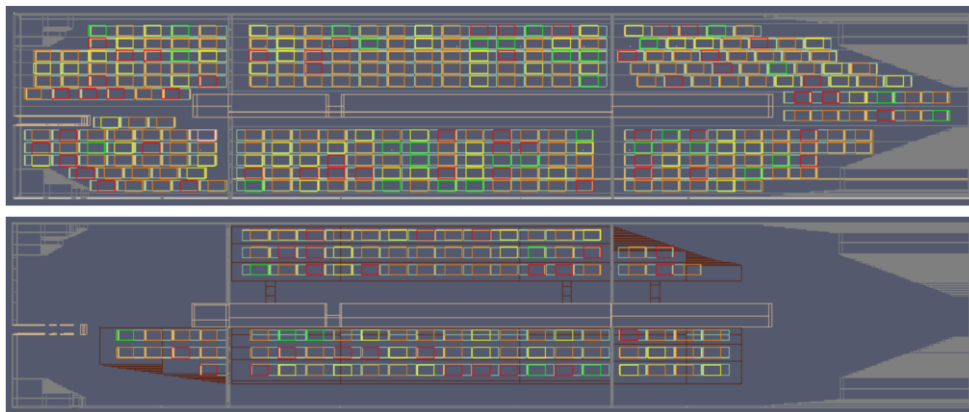

Figure 6.37: Car placement example showing deck 3 and deck 4. On deck 3 an additional car row is placed to test a worst-case situation. The cars are placed 20 cm nose to bumper. The distance to the sides of the cars on deck 3 varies between 20 and 40 cm. The cars on the ramp are placed 1.2 meters between each other.

6.9.2 Numerical Set-up

Thermal properties of materials used in the simulation are presented in Table 6.9. Higher emissivity numbers are assumed to represent an assumed soot deposition on the insulation during the fire. It is important to note that thermal properties of materials change with temperature, which is not accounted for in the current simulations. For the insulation a fast sensitivity analysis was made using a two-zone model, it was concluded that changes of specific heat in conditions like the current simulation have negligible impact on surface temperature. Additionally, the ship's insulation has been upgraded, thus it currently consists of layers of different insulation and the insulation types differ throughout the ceiling of the car hold. A decision was to use one type of insulation with properties given in Table 6.9, as it is neither practicable nor important for the outcome to model insulation materials in such a detail.

Table 6.9: Thermal properties of materials used in FDS simulations.

Material	Thickness [m]	Specific heat [kJ/kgK]	Conductivity	Material	Thickness [m]	Specific heat [kJ/kgK]
steel	0.01	0.46	45.8	7850	0.95*	[28]
aluminum	0.01	0.883	164	2787	0.9*	[29]
searox	0.1	0.8	0.035	110	0.9*	[30]
rubber	-	1.88	0.13	910	-	[29]

*Higher emissivity assuming insulation will be covered by soot.

Table 6.9 also shows the thicknesses of materials used in the simulation where applicable. PEARL SEAWAYS is constructed of A40 steel plates. The thickness of these steel plates differs slightly between different frames between 11 and 12.5 mm. The flooding doors are made of aluminum with not known properties, therefore a choice of a suitable aluminum alloy was made for thermal properties, given in Table 6.9. The ceiling is represented by two layers of materials: 0.1 m insulation and 0.1 m steel on the top of it.

Ventilation setting tested and described in cold simulations 6.7.1 were adopted for the current simulations. There is a higher ventilation capacity available on the ship, but the setting in simulation was used as it is currently in use for the duration of the trip, i.e., one fan is on with a capacity of 70000 m³/h. According to the rules 10 air changes per hour must be made at sea (20 air changes at port). The air flow is regulated from the engine room by an engineer. There are 4 boosters with capacity of 6800 m³/h located at the ceiling, 2 on each side of the ship, but these are not in use and are obstructed by ceiling installations. Ventilation can be stopped from the bridge, cargo control room and engine room. Reaction time depends on how close the responsible person is to the switch, and it ranges from a few seconds to a few minutes. In the current fire scenario, the ventilation is switched off after 2 minutes.

Combined smoke and heat detectors are installed on both decks 3 and 4. According to Concilium data sheet [31] for the types of detectors used onboard, the smoke and heat detector functions are independent. For the heat detector alarm temperature is 57 °C. The detectors were modelled as separate smoke and heat detectors. No information for modelling was possible to obtain from detectors supplier, therefore smoke detectors were defined by default values activated at 3.24 obscuration value with detectors characteristic length of 1.8. Heat detectors were set to activation temperature of 57 °C and an RTI of 1. All the detectors are positioned in accordance with the provided drawings.

6.9.3 Simulation Results

Table 6.10 is repeated here for convenience, showing simulation description and differences in fire scenarios.

Table 6.10: Summary of fire scenarios PEARL SEAWAYS

N	Simulation ID	Description	Ignition car, peak HHR [MW]	Distance [cm]	Car position
1	20_1	Distance between cars 20 cm	10441	20	zone 1
2	40_1	Distance between cars 40 cm	10441	40	zone 1
3	40_2	Ignition in zone 2	10441	40	zone 2

4	40_3	Ignition in zone 3	10441	40	zone 3
5	40_4	Test fire curve	7069	40	zone 1
6	40_5	Ventilation on	10441	40	zone 3
7	40_6	Sprinkler – 5 min	10441	40	zone 2
8	40_7	Sprinkler – 10 min	10441	40	zone 2

6.9.4 Effects of Smoke Spread

Smoke spread inside the car deck during the fire can be illustrated with ignition cars placed in the first zone. Figure 37 shows how smoke was filling the car deck in scenario 20_1. It is seen that the smoke spreads freely between the two decks due to the gap between the flood door and the ramp. At 200 seconds the conditions in the first zone became untenable. At 300 seconds with one vehicle burning, the smoke descended to about 1.2 meters height and filled in the headspace in the adjacent section.

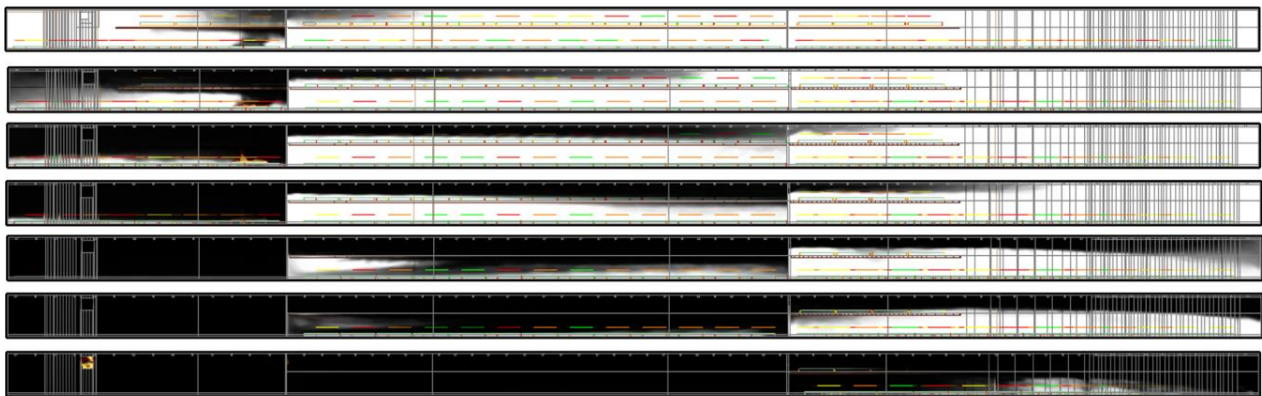

Figure 6.38: Smoke spread in two scenario 20_1. This figure shows smoke at times 100, 200, 300, 400, 700, 1400 and 1600 seconds.

Visibility results, Figure 6.39 and Figure 6.40, from current simulations indicate preferable ways for firefighters to enter deck 3 depending on the time after the fire starts and position of first smoke detectors activated. Assuming the time of first detection activation is noted and its location is known, a fire in zone 1 would still be reachable 5 minutes after the fire starts, especially if fire starts due to the failure of EV battery (see scenario 40_4). The fire can be reached from the opposite side if a car ignited is located on a starboard or a port side.

If the entrance must be done later, it is even more important to enter from the port side as the smoke spread will proceed towards zone 2 on the fire side. The principle is the same for the fire in the bow, where the smoke will spread to the closest zone 2, limiting the entrance from this side, see Figure 6.41 for temperatures in zone 2 after approximately 15 minutes reaching 300-400 °C which has a potential to ignite the vehicles on the ramp in that location.

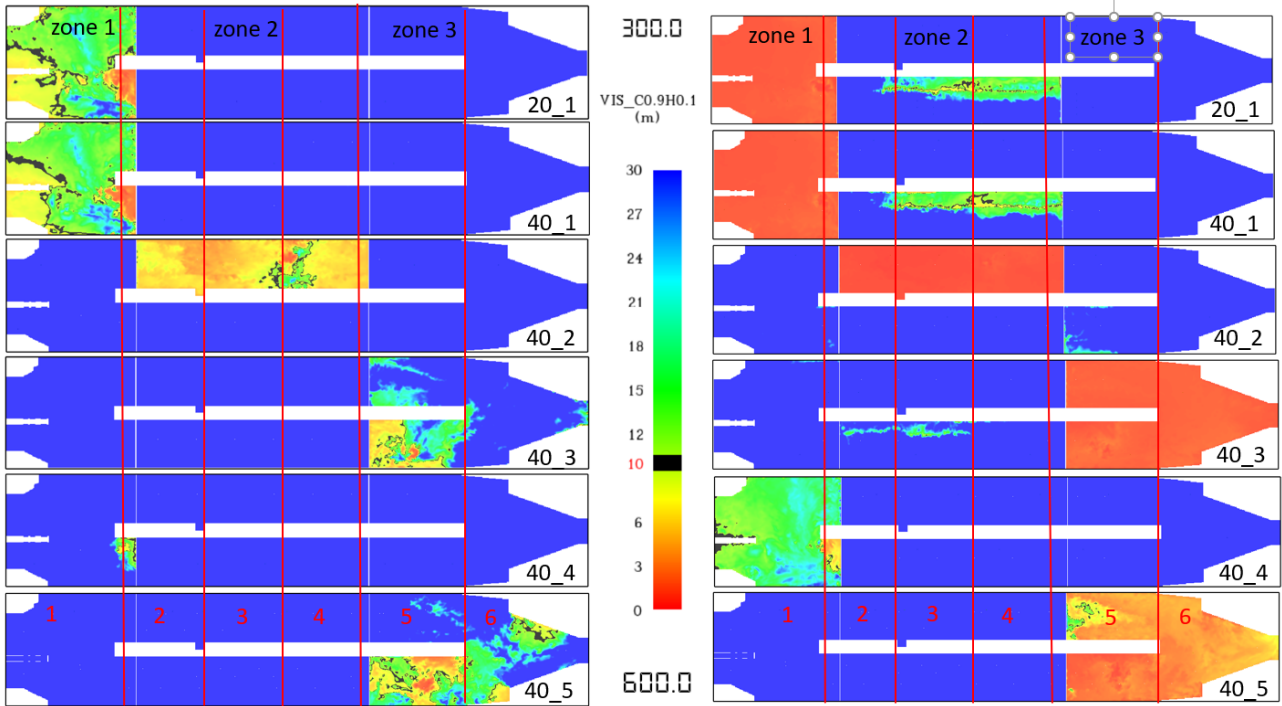

Figure 6.39: Visibility at 2.2 meters height at 300 seconds (left) and 600 seconds (right) after ignition. Scenarios 20_1 and 40_1 have similar visibility, whereas in scenario 40_2 visibility is almost fully lost in the section where the fire has started. Scenarios 40_3 and 40_4 exhibit better overall visibility at the same time. Red lines and numbering denote the approximate positions of sprinkler zones. Maximum activation is limited to two zones.

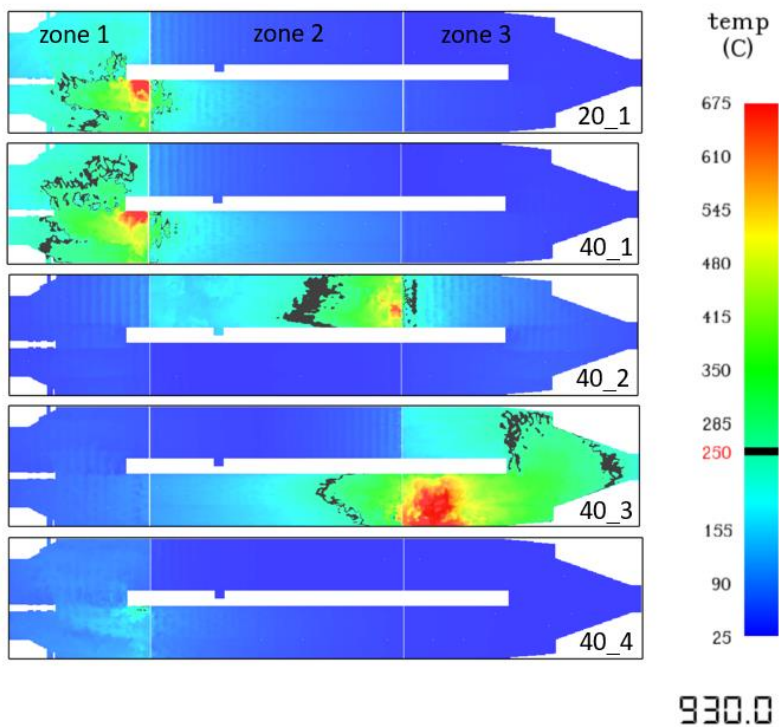

Figure 6.40: Temperature at the height of 4.8 meters at 930 seconds of simulation time for all different scenarios with 250 °C threshold value



Figure 6.41: Smoke development seen from above at 600 s from the fire start in six different scenarios. Assuming the time of first detection activation is noted and its location is known, a fire in zone 1 would still be reachable 5 minutes after the fire starts, especially if a slow fire starts due to the failure of EV battery (see scenario 40_4).

6.9.5 Effect of Distance Between the Cars

The ignition videos are identical in scenarios 20_1 and 40_1, therefore the smoke spread at the first stages of fire does not differ. Comparison of wall temperature in vicinity of the first ignited vehicle for scenarios 20_1 and 40_1 is shown in Figure 6.43, where wall temperature for the cars marked as 1, 2 and 3 in Figure 6.42 is analyzed. The distance reduction between the cars from 40 to 20 cm made a difference (ignition-no ignition) in 2 of 3 near-by vehicles: cars 1 and 2 ignited (defined here at 250 °C). The onset of 250 °C for nearest vehicle 3 is also later when cars are 20 cm further from each other.

Several cars located on deck 4 (ramp) have also ignited, but there were no significant differences between the ignition time for these cars. This is due to the hot smoke layer formed at the level of deck 4 where the cars are located, showing that there is a danger of fire growth on the ramp if the fire is not controlled.

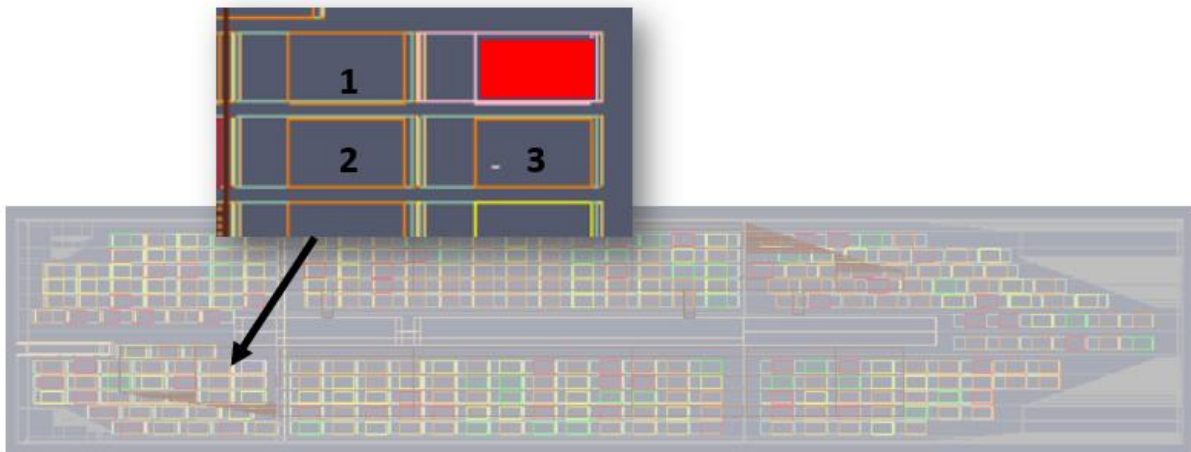

Figure 6.42: Location of cars 1, 2 and 3 around the vehicle that was ignited first (marked red) on the deck 3

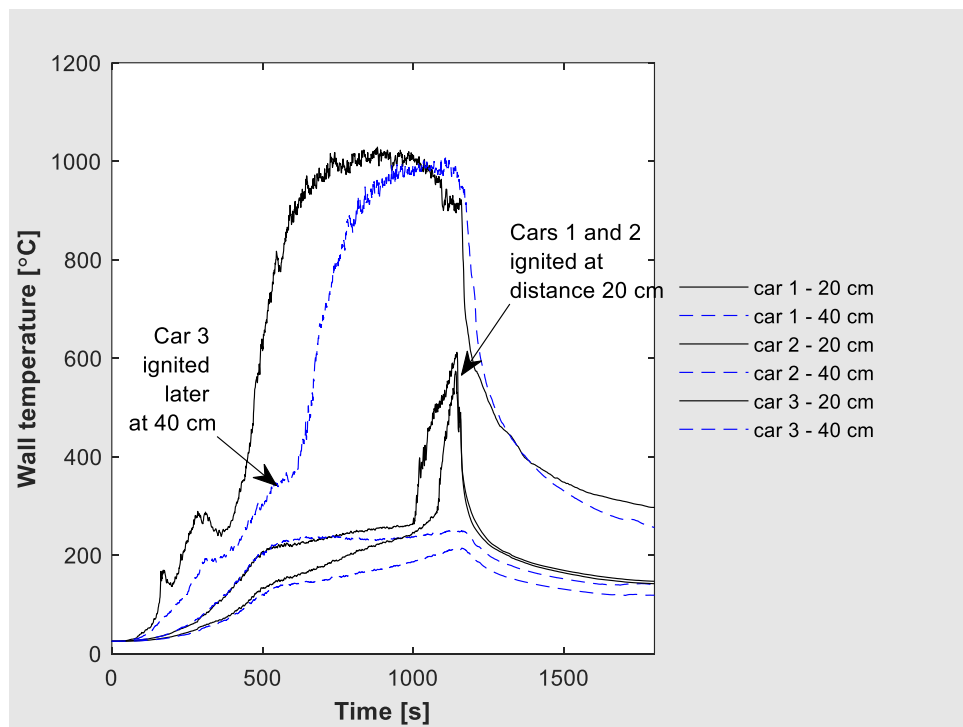

Figure 6.43: Wall temperature for 3 vehicles located in direct vicinity to the first ignited vehicle. The distance reduction between the cars from 40 to 20 cm made a difference (ignition-no ignition) in 2 of 3 near-by vehicles: cars 1 and 2 ignited (defined here at 250°C). The onset of 250°C for nearest vehicle 3 is also later when cars are 20 cm further from each other.

6.9.6 Fire Spread between the Vehicles

Comparing simulation results shows that the number of cars ignited in each scenario differs, see Table 6.11. In general, when cars are placed closer to each other: 12 cars ignite when cars are placed 20 cm from each other, compared to 11 cars with spacing of 40 cm. The ignition of the second car for cars placed 20 cm from each other is about 3 minutes earlier than when the cars are placed 40 cm from each other. The difference in number of ignited cars is not so large, because the hot gases from the first car ignited initiates ignition of

the cars on the ramp, which are placed similar in both scenarios. The slight difference can be explained by an additional car igniting earlier on deck 3 due to the closer distance.

Table 6.11: Total number of cars ignited within 30 minutes in different scenarios, including the ignition car

Scenario	20_1	40_1	40_2	40_3	40_4	40_5	40_6	40_7
Total cars ignited	13	10	21	34	3	95	1	5
Detection time [s]	3.9	30.4	36.8	28.5	66.9	23	36.8	36.8

In Figure 6.40 temperature slices are shown at the time of 930 seconds for scenarios 20_1 and 40_1. At this time, the fire has spread to 2 vehicles on deck 3 and to one vehicle on deck 4 in both scenarios, but ignition started earlier in case of 20 cm distance between the cars, thus the fire grew larger resulting in higher temperatures.

Placing the ignition car in a different location changed the total number of cars ignited. Position near the bow (40_3) results in significantly more cars igniting. As Figure 6.40 shows, the temperatures over 675 °C are developed over a much larger area in zone 3 (40_3) compared to when the car is placed in zones 1 and 2 (40_1 and 40_2). The cause of this can be due to one small opening left opened in zone 1 for the purpose of simulation of air leakage and to avoid the pressure instabilities in the simulation. The car deck is not perfectly insulated from air leak in real life. This allows the hot gas to escape and potentially resulting in lower local temperatures. The results show that if a fire is not controlled by the sprinkler system, it will spread fast to many cars. The scenario 40_3 showed a high fire spread from 10 to 15 minutes of simulation (involving 13 extra cars).

6.9.7 Effect of HRR

Latest full-scale tests of EVs [32] have shown HRR curves with slower growth phase and lower peak HRR. It was therefore decided to use one of such curves in a simulation to see how it compares to a current design curve. For the simulation, the growth phase that showed no significant growth was cut out.

The test EV HRR curve was used in a scenario 40_4 (6926 kW at peak) and it resulted in a fire spread to 3 cars in total during the whole duration of simulation. The onset of ignition temperature occurred after 930 s.

A fire scenario where an EV that does not cause explosion or a jet flame gives much more time for the crew and the fire fighters to control the situation. Nevertheless, the difficulty of handling a battery fire onboard a ship is apparent in any scenario because the battery produces extra hydrogen fluoride and can reignite. Control of such fire is difficult due to the cars being located close to each other and the difficulty to reach the battery itself for cooling purposes.

6.9.8 Effect of Ventilation

Smoke control using the existing system could potentially remove smoke and thus heat from the fire, allow more successful firefighter operation and help to get rid of toxic and hazardous gases that are produced when an EV is burning and is being extinguished. Therefore, one scenario was modelled with air intake

opened and ventilation set to full available capacity during the fire. It resulted in the largest fire with a total of 95 vehicles ignited due to the supply of oxygen and intense mixing.

Comparison of fire spread (Table 6.11) shows that keeping the ventilation on highest possible capacity does not improve the visibility at early stages of the fire (5 or 10 minutes, Figure 6.39), and instead leads to fire spread to larger number of vehicles in later stages. Figure 6.41 shows smoke spread seen from above at time 600 s for different fire scenarios. It is seen that scenario 40_5 with ventilation keeps the smoke in zone 2 withing first 600 seconds (compared to scenario 40_3). Accumulation of smoke leads to a larger number of vehicles being ignited after 16 minutes from the fire onset.

For the scenarios where ventilation is assumed to be closed within 2 minutes. After the fire starts, the worst position of the ignition vehicle is the bow (zone 3), where the fire has a potential to spread to more cars if not controlled at early stages. The second worst position is the aft (zone 1), where a similar challenge arises. When a fire occurs in zone 2, smoke spreads to the neighboring zones, but mostly collected within port or a starboard side of the ship depending on where the fire has started. Nevertheless, smoke is free to spread to other parts of the ship due to the 1-meter gap in the flood doors.

6.9.9 Effect of Sprinklers Modelling

Two scenarios were run as a rough estimate of sprinklers impact on the fire spread. Depending on the reaction time for activation of the drencher system, the number of cars involved in fire in the current scenario differs from 1 to 5 vehicles in total before the fire is controlled, i.e., HRR is assumed to be constant.

The detection times for design fire curve (10441 kW) are in order of 30 seconds, changing slightly depending on the ignition car placement. With test fire curve (7069 kW) the detection time can be over 1 minute. It can even take longer time, because the test fire curve in this scenario was changed and the starting stage with extremely low heat release rate was cut out. This shows the need for alternative early detection methods. If sprinklers are activated within 5 minutes from the fire start in the right zone, then the fire can be contained for all scenarios.

The most favorable conditions can be created using early activation of the sprinklers in the fire location. It is crucial to be able to see the sequence of smoke detectors activation, especially for a decision on which of available zones to activate when a fire is detected in the middle of the ship (zone 2). The placement of the cars with as large distance as possible gives only a small-time advantage (for example approximately 2 minutes delay in fire spread to the second vehicle). The position of ignition vehicle based on the current scenarios is a favorable condition, both due to difference in a fire spread and better ability to control the fire. Nevertheless, a fire in 2010 may have happened in a most favorable location but was unfortunate to spread to a heavy vehicle placed nearby and to the other side of the nearest flood door (zone 2).

6.10 References

- [1] T. Marton, A. Dederichs, and L. Giuliani, “Modelling of fire in an open car park,” 2015.
- [2] C. Lam, D. MacNeil, R. Kroeker, G. Lougheed, and G. Lalime, “Full-scale fire testing of electric and internal combustion engine vehicles,” in *Fires in Vehicles - FIVE 2014*, 2014, pp. 221–230.
- [3] D. Joyeux, “Natural Fires in Closed Car Parks - Car Fire Tests,” 1997.
- [4] NFPA, “Guide for Smoke and Heat Venting, NFPA 204M,” p. 1985, 1985.
- [5] H. Boehmer, M. Klassen, and S. Olenick, “Modern Vehicle Hazards in Parking Structures and Vehicle Carriers,” no. July, p. 60, 2020, [Online]. Available: <https://www.nfpa.org/News-and-Research/Data-research-and-tools/Building-and-Life-Safety/Modern-Vehicle-Hazards-in-Parking-Garages-Vehicle-Carriers>.
- [6] Mohd Zahirasri Mohd Tohir, “Multiple Vehicle Design Fire Scenarios in Car Parking Buildings,” PhD Thesis, 2015.
- [7] Y. Shintani et al., “Experimental Investigation of Burning Behavior of Automobiles,” pp. 1–13, 2004.
- [8] M. Mohd Tohir and M. Spearpoint, “Distribution analysis of the fire severity characteristics of single passenger road vehicles using heat release rate data,” *Fire Sci. Rev.*, vol. 2, no. 1, p. 5, 2013, doi: 10.1186/2193-0414-2-5.
- [9] Fire Protection Research Foundation (NFPA), “Modern Vehicle Hazards in Parking Structures and Vehicle Carriers,” no. July, p. 60, 2020, [Online]. Available: <https://www.nfpa.org/News-and-Research/Data-research-and-tools/Building-and-Life-Safety/Modern-Vehicle-Hazards-in-Parking-Garages-Vehicle-Carriers>.
- [10] O. Willstrand et al., “Toxic Gases from Fire in Electric Vehicles Toxic Gases from Fire in Electric Vehicles,” Borås, 2020.
- [11] P. C. R. Collier, “Car Parks – Fires Involving modern cars and stacking systems,” *BRANZ Build. Res. Levy.*, vol. ISSN: 1179, p. 108, 2011.
- [12] A. J. (2007). de Feijter, M. P. and Breunese, “Investigation of fire in the Lloydstraat car park, Rotterdam. Efectis Nederland BV, Postbus, Netherlands, 2007-Efectis-R0894(E).,” vol. 0894, p. 2007, 2007.
- [13] D. W. L. Jansen, “AUTOBRANDEN IN PARKEERGARAGES - brandscenario ' s , brandsimulaties en de gevolgen voor constructies.,” p. 145, 2010.
- [14] L. Baert and B. Merci, “Evaluatie en ontwikkeling van methoden voor een brandveilig ontwerp van RWA installaties in ondergrondse parkeergarages. Master’s thesis, Universiteit Gent.,” p. 2011, 2011.
- [15] A. Lecocq, M. Bertana, B. Truchot, and G. Marlair, “Comparison of the Fire Consequences of an Electric Vehicle and an Internal Combustion Engine Vehicle,” *Int. Conf. Fires Veh.*, pp. 183–194, 2012.
- [16] H. Boehmer, M. Klassen, and S. Olenick, “Modern Vehicle Hazards in Parking Structures and Vehicle Carriers,” no. July, p. 60, 2020, [Online]. Available: <https://www.nfpa.org/News-and-Research/Data-research-and-tools/Building-and-Life-Safety/Modern-Vehicle-Hazards-in-Parking-Garages-Vehicle-Carriers>.

- [17] BRE, “Fire spread in car parks,” 2010, [Online]. Available: <http://webarchive.nationalarchives.gov.uk/20120919132719/http://www.communities.gov.uk/documents/planningandbuilding/pdf/1795610.pdf>.
- [18] Wikipedia, “Bumper (car).” [https://en.wikipedia.org/wiki/Bumper_\(car\)](https://en.wikipedia.org/wiki/Bumper_(car)) (accessed Aug. 12, 2021).
- [19] K. McGrattan, S. Hostikka, R. McDermott, J. Floyd, C. Weinschenk, and K. Overhold, “Sixth Edition Fire Dynamics Simulator User’s Guide (FDS),” NIST Spec. Publ. 1019, vol. Sixth Edit, 2020.
- [20] K. B. McGrattan, S. Hostikka, R. McDermott, and M. Vanella, “Fire Dynamics Simulator Technical Validation Guide,” vol. 3, 2006, [Online]. Available: <https://nvlpubs.nist.gov/nistpubs/Legacy/SP/nistspecialpublication1018.pdf>.
- [21] AZO Materials, “Aluminium Alloys - Aluminium 5083 Properties, Fabrication and Applications,” 2022, [Online]. Available: <https://www.azom.com/article.aspx?ArticleID=2804>.
- [22] American Elements, “Aluminum Honeycomb Properties (Theoretical),” 2022. <https://www.americanelements.com/aluminum-honeycomb-7429-90-5>.
- [23] A. Ben-Yakar, A. Harkin, J. Ashmore, R. L. Byer, and H. A. Stone, “Thermal and fluid processes of a thin melt zone during femtosecond laser ablation of glass: the formation of rims by single laser pulses,” J. Phys. D. Appl. Phys., vol. 40, no. 5, pp. 1447–1459, Feb. 2007, doi: 10.1088/0022-3727/40/5/021.
- [24] Á. Lakatos, I. Csarnovics, and A. Csík, “Systematic Analysis of Micro-Fiber Thermal Insulations from a Thermal Properties Point of View,” Appl. Sci., vol. 11, no. 11, 2021, doi: 10.3390/app11114943.
- [25] F. Czerwinski, “Thermal stability of aluminum alloys,” Materials (Basel), vol. 13, no. 15, pp. 1–49, 2020, doi: 10.3390/ma13153441.
- [26] International Maritime Organisation, “SOLAS consolidated edition 2014.” IMO Publishing, 2014, [Online]. Available: www.imo.org.
- [27] Division for Investigation of Maritime Accidents of the Danish Maritime Authority/ Danish Maritime Accident Investigation Board, “PEARL OF SCANDINAVIA Fire,” pp. 1–14, November 2010.
- [28] D. Drysdale, An introduction to fire dynamics, 3rd edition. 2011.
- [29] M. J. Hurley, SFPE handbook of fire protection engineering (1995), vol. 29, no. 5. 1997.
- [30] ROCKWOOL, “SeaRox Marine and offshore insulation.” ROCKWOOL BV, pp. 1–32, 2018, [Online]. Available: www.isover.com.
- [31] Concilium building safety, “Data sheet: combined optical and heat detector EV-PP/OA130,” no. 040200. 2020.
- [32] L. Vylund and P. Mindykowski, “Methods and equipment for firefighting with alternative fuel vehicles in ro-ro spaces,” Borås, 2019.